

Headquarters

Lifud Technology Co., Ltd.

Building B, Kutto Industrial Park, NO.26 Xinhe Road,
Xinqiao Street, Bao'an District, Shenzhen, China 518104
Tel: +86-755-83739299
Fax: +86-755-88739228
Email: sales@lifud.com

Factory

Sichuan: Lifud Technology Park, Shigao Economic Development
Zone, Meishan City, Sichuan Province, China
Shenzhen: Building B, Kutto Industrial Park, NO.24 Xinhe Road,
Xinqiao Street, Bao'an District, Shenzhen, China 518104

Subsidiary

Lifud Europe GmbH

Burgunderstrasse 27, 40549 Düsseldorf, Germany
Email: liffe@lifud.com



Website



Wechat



LinkedIn

Contact Your Local Distributor



Leading Supplier of
**LED Driver & Intelligent
System Solution**





Company Profile

\$10_M
Registered Capital

14_{yrs}
History

100₊
Senior Technicians

66,666_{m²}
Industrial Park

4,000₊
Customers

150_M
Drivers exported

Lifud Technology Co., Ltd. has always aspired to become a "leading supplier of LED driver and intelligent system solution". Since 2007 when Lifud was established, Lifud team has been sticking to the value concept of "Integrity, responsibility and dedication". With unceasing technology innovation, we take it as our mission to improve human living environment and living quality with energy-saving, healthy and environmental friendly products, so as to achieve our vision of making energy more efficient and cleaner.

With headquarters locating in Shenzhen, Lifud is Shenzhen high-tech enterprise and national high-tech enterprise. We have more than 100 senior technicians and product developers, and set up cooperation project with universities such as Fuzhou University, Southwest Jiaotong University and etc. Lifud also built its own UL and DALI authorized laboratories, as well as a 66 thousand square meters industrial park, which can meet self-development need and provide a full range of supporting service for our customers.

In the past 14 years, Lifud has created value for near 4000 partners with leading technology, high quality product and considerate service. Lifud is ISO9001:2015 quality management system certified, ISO14001 : 2015 environment management system certified and intellectual property management system certified. Lifud also won the honors, including Sichuan Famous Brand, Guangdong Famous Brand, TOP 10 International Competitiveness of Chinese LED Power Supply Enterprise, Gold Award of the Sixth LED Innovation Conference, LpS Digital Exhibition Best Product Award 2020 and etc. Lifud will spare no efforts to achieve win-win cooperation with customers and develop to be a world-class OBM enterprise.



Technology

Adhere to technological innovation for developing competitive product

- Cooperate with universities to work on frontier research projects in electronic technology.
- Independently designed two-in-one master chip, DDM01 dimming chip, etc.
- Established the second R&D center in Chengdu to specialize in intelligent system technology.
- Theoretical research + application innovation + supply chain integration, this combination continually supports technology innovation.
- Invested millions of CNY for new devices to build environment /safety-standard /EMC/Intelligent system testing lab.
- Patented magnetic integration technology, Lifud's revolutionary innovation and won LpS Digital Exhibition Best Product Award 2020.



Quality

Meticulous design+strict management, target of 500PPM

- Using AOI (Automated Optical Inspection)and high-precision fixed-point-welding equipment. Using ATE (Automatic Test Equipment).
- 5 design reviews, BCA, PD, EVT, DVT & PVT.
- All core components are provided by well-known brands.
- 4 procedures for VM team to examine incoming materials.
- Test under extreme environment and verify the long-term lifetime of products.



Service

Customized service to achieve 100% satisfaction

- Brought in the SRD consultant team to improve the customer service system.
- Provide with professional and customized service to VIP customers.
- Established South China warehouse center to shorten lead time.
- Work with customers on business public relations and help them to obtain orders.
- Implement a service performance evaluation mechanism, strengthen service quality and continuously improve customer satisfaction.



LIFUD Philosophy

Vision

Make energy more efficient and cleaner

Mission

Committed to technological innovation, improving human living environment and the quality of life

Core Value

Integrity, responsibility, dedication

Quality Policy

Create value for customers with excellent quality, continuous innovation and perfect service

Cooperation Concept

One should treat others as one would like to be treated



LIFUD History

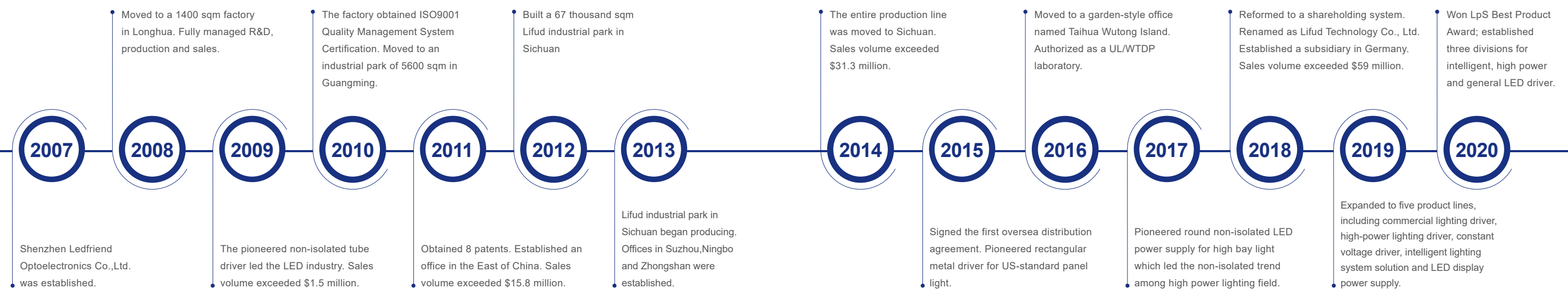

Global Sales Network

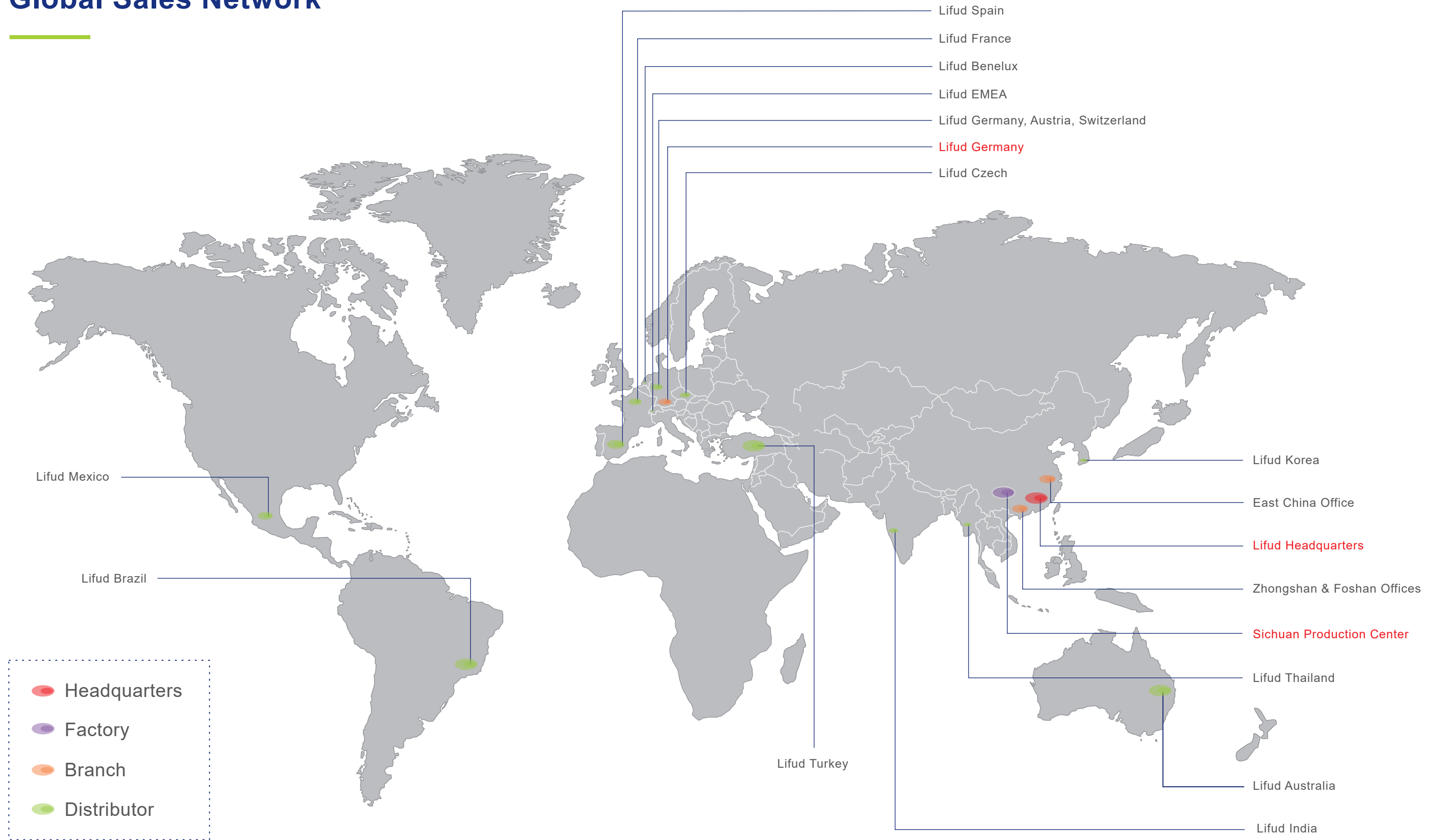

Application



- Taco Cabana Chain Restaurant
- Blackpool Tower
- Riga Central Market in Latvia
- Garden Malls in Kuala Lumpur
- Stores of Nike and Adidas
- Wuxi No.1 High School
- Guiyang No.1 High School
- Shenzhen Longgang Baolong Foreign Language School
- Shenzhen Xinsha Primary School
- Anacortes High School in Washington
- University of Maryland
- University College Cork
- Sichuan International Hospital
- BMW 4S stores in Spain, Guiyang, Zunyi
- Jewelry stores of Chow Tai Fook and Chow Sang Sang
- Xiaomi Exclusive Store
- Huawei Exclusive Store
- Qian Dama Fresh Store
- Heli Market
- Shenzhen Maoye Mall
- Chengdu New Century Global Center
- Dongguan Guo Mao Mall
- Nanchang Wuyue Square

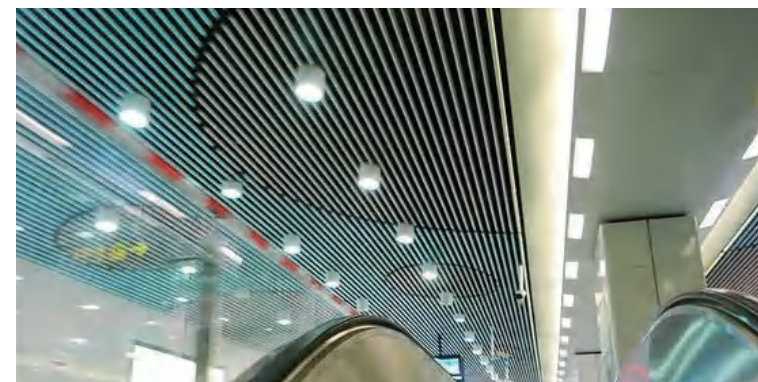

- Dubai Mercure Hotel
- Hotels in Las Vegas, US
- Sheraton Qiandao Lake Resort
- Pullman Fuzhou Tahoe
- Hangzhou New Century Grand Hotel
- Five-star hotel in Sanya, Hainan
- Shenzhen Jirock Hotel
- Beijing Friendship Hotel
- Chengdu Metro Line 5
- Shanghai Metro Line 15
- Changchun Rail Transit Line 1
- Qingdao Metro Line 11
- Wuxi Metro Line 1
- Fuzhou Metro Line 2
- Shenzhen Futian Railway Station
- Shenyang Subway Station
- Chile Subway
- Sunan Shuofang International Airport
- Norwich International Airport
- Frankfurt Airport
- Nanjing Yangtze River Bridge
- Hokkaido Railway Station

High Power LED Driver

Street Light AC220-240V: C.C LF-EANxxx*10-75W 21

Street Light AC220-240V: C.C LF-GOExxxYE(E)/YF(E)*25-100W 22

Street Light AC100-277V: C.C LF-GOExxxYE/YF*30-75W 23

Street Light AC100-277V: C.C LF-GOExxxYE/YF*110-320W 24

Street Light AC100-277V: C.P LF-GOExxxYJ/YK*110-320W 25

Street Light AC100-277V: C.P LF-GOExxxYH*110-320W 26

Industrial AC100-277V: C.C LF-FHBxxxYA/YB/YCIV*100-240W 27

Industrial AC220-240V: C.C LF-FHBxxxYD/YE/YJIV*80-240W 28

LED Strip AC100-277V: C.V LF-GOExxxYV*75-250W 29

LED Strip AC220-240V: C.V LF-KANxxx*360-400W 30

Intelligent LED Driver

DALI AC220-240V: C.C LF-GSDxxxYK/YG*4-50W 35

DALI AC220-240V: C.C LF-GSDxxxPF*6-40W 36

DALI AC220-240V: C.C LF-AADxxx*4-40W 37

DALI AC220-240V: C.C LF-GSDxxxYC*11-60W 38

DALI AC220-240V: C.C LF-GSDxxxYE*4-80W 39

DALI AC100-277V: C.C LF-GSD045YB*34-44W 40

DALI Converter: LF-SCD010A/B/C 41

DALI Bus Power: Supply AC100-240V: LF-GSD005YD 42

DALI AC220-240V: C.C LF-GSDxxxYH*4-50W 43

DALI AC220-240V: C.V LF-KADxxx12/24*100-240W 44

DALI AC220-240V: C.V LF-GSDxxxYVxxA*75-150W 45

DALI AC220-240V: C.V LF-GSDxxxYVxxB*75-150W 46

Triac AC220-240V: C.C LF-GDExxxYG*1-30W 48

Triac AC100-120V: C.C LF-GDExxxYD*8-30W 49

Triac AC220-240V: C.C LF-AATxxx*8-40W 50

Triac AC220-240V: C.V LF-GATxxx*75-150W 51

0-10V AC220-240V: C.V LF-GDExxxYV*75-150W 52

0-10V AC220-240V: C.C LF-AAAx*8-40W 53

Emergency AC100-277V: C.P LF-GSPxxxYD*14-40W 54

Emergency AC100-277V: C.P LF-GSP012YH*5/7/10/12W 55

Emergency AC100-277V: C.P LF-GSPxxxYG*5/7/10/12W 56

Commercial Lighting LED Driver

AC220-240V Track / Down / Panel Light: C.C LF-GIRxxxYS/YS(B)*1-7W 59

AC220-240V Track / Down / Panel Light: C.C LF-GIRxxxYS*5-24W 60

AC220-240V Track / Down / Panel Light: C.C LF--GIRxxxYM*8-60W 61

AC220-240V Track / Down / Panel Light: C.C LF-GIFxxxYF*15-40W 62

AC220-240V Track / Down / Panel Light: C.C LF-GICxxxYS*16-25W 63

AC220-240V Track / Down / Panel Light: C.C LF-GICxxxYB*12-40W 64

AC220-240V Track / Down / Panel Light: C.C LF-GIFxxxYAI*24-62W 65

AC220-240V Track / Down / Panel Light: C.C LF-GIFxxxYS*24-42W 66

AC100-277V Track / Down / Panel Light: C.C LF-GIRxxxYK*15-50W 67

AC100-277V Track / Down / Panel Light: C.C LF-GIFxxxYC*22-40W 68

AC100-277V Track / Down / Panel Light: C.C LF-GMDxxxYS V *3-65W 69

AC100-277V Track / Down / Panel Light: C.C LF-GMDxxxYB V *8-65W 70

AC100-277V Track / Down / Panel Light: C.C LF-GLDxxxYJ*35-55W 71

AC100-277V Track / Down / Panel Light: C.C LF-GLDxxxYI*35-55W 72

AC220-240V Linear Light: C.C LF-FMRxxxYS*11-60W 73

AC220-240V Linear Light: C.C LF-FMRxxxYS II *11-60W 74

AC220-240V Linear Light: C.C LF-GMRxxxYE II *8-60W 75

AC220-240V Linear Light: C.C LF-GMRxxxYS II *8-80W 76

AC220-240V Linear Light: C.C LF-GLDxxxYE*11-80W 77

AC100-277V Linear Light: C.C LF-GLDxxxYS*11-65W 78

C.C : Constant-Current
C.V : Constant-Voltage
C.P : Constant-Power

Statement: the appearance, color and parameters of the products listed in this catalogue are for reference only. Lifud Technology Co., Ltd. reserves all rights to modify or cancel the information and related parameters in this catalogue without prior notice. Please contact our sales for the latest specification.

Function Selection Table

Input Voltage	Output Power	Model	Picture	Dimming Mode				Tunable White	Adjustable Current	12V Auxiliary Power Supply	IP Rating	Flicker Free	Warranty (yrs)	Certification	Page
				0-10V, PWM & Rx	DALI	Push	Triac								

Indoor: LED track light, down light, panel light, ceiling light, grille light, etc.

220-240Vac	4-50W	LF-GSDxxxYK/YG <small>NEW</small>			✓	✓		✓	✓		IP20	✓	5	ENEC,CE,CB,RCM,SAA,CCC,DALI2.0	35
	6-40W	LF-GSDxxxPF <small>NEW</small>			✓	✓			✓		IP20	✓	5	ENEC,CE,CB,RCM,SAA,CCC,DALI2.0	36
	4-40W	LF-AADxxx <small>NEW</small>			✓	✓			✓		IP20	✓	5	ENEC,CE,CB,RCM,SAA,CCC,DALI2.0	37
	11-60W	LF-GSDxxxYC		✓	✓	✓			✓		IP20	✓	7	ENEC,CE,CB,RCM,SAA,CCC,DALI2.0	38
	1-30W	LF-GDExxxYG					✓		✓		IP20	✓	5	ENEC,CE,CB,RCM,SAA,CCC	48
	8-40W	LF-AATxxx <small>NEW</small>					✓				IP20	✓	5	ENEC,CE,CB,RCM,SAA,CCC	50
	8-40W	LF-AAAxix <small>NEW</small>		✓					✓	✓	IP20	✓	5	ENEC,CE,CB,RCM,SAA,CCC	53
	1-7W	LF-GIRxxxYS/YS(B) <small>NEW</small>									IP20	✓	5/3	CE,CB,CCC,RCM,SAA	59
	5-24W	LF-GIRxxxYS									IP20	✓	5	CE,CB,CCC,RCM,TUV,SAA	60
	8-60W	LF-GIRxxxYM									IP20		5	CE,CB,CCC,TUV,RCM,ENEC,SAA	61
	15-40W	LF-GIFxxxYF									IP20	✓	5	CE,CB,CCC,RCM,ENEC,SAA	62
	16-20W	LF-GICxxxYS									IP40	✓	5	CE,CB,CCC,RCM,ENEC,SAA	63
	12-42W	LF-GICxxxYB									IP20		3	CE,CB,CCC,RCM,ENEC,SAA	64
	24-62W	LF-GIFxxxYAI									IP20	✓	5	CE,CB,CCC,RCM,ENEC,SAA	65
24-42W	LF-GIFxxxYS <small>NEW</small>									IP20	✓	5	CE,CB,CCC,RCM,ENEC,SAA	66	
100-277Vac	15-50W	LF-GIRxxxYK									IP20		5	CE,CB,RCM,ENEC,FCC,UL,SAA	67
	22-40W	LF-GIFxxxYC									IP20	✓	5	CE,CB,ENEC,RCM,SAA	68
	3-65W	LF-GMDxxxYS V		✓								✓	5	FCC,UL	69
	8-65W	LF-GMDxxxYB V		✓									5	FCC,UL	70
	35-55W	LF-GLDxxxYJ		✓									5	FCC,UL	71
	35-55W	LF-GLDxxxYI		✓								✓	5	FCC,UL	72

Input Voltage	Output Power	Model	Picture	Dimming Mode				Tunable White	Adjustable Current	12V Auxiliary Power Supply	IP Rating	Flicker Free	Warranty yrs	Certification	Page
				0-10V, PWM & Rx	DALI	Push	Triac								
100-120Vac	8-30W	LF-GDExxxYD					✓				IP20		5	UL,FCC	49

Indoor: LED linear light, tri-proof light, etc.







220-240Vac	4-80W	LF-GSDxxxYE			✓	✓			✓		IP20	✓	5	ENEC,CE,CB,RCM,SAA,CCC,DALI2.0	39
	11-60W	LF-FMRxxxYS							✓			✓	5	CE,CB,CCC,RCM,ENEC,SAA	73
	11-60W	LF-FMRxxxYS II						✓	✓			✓	5	CE,CB,CCC,RCM,ENEC,SAA	74
	8-60W	LF-GMRxxxYE II											5	CE,CB,CCC,RCM,ENEC,SAA	75
	8-80W	LF-GMRxxxYS II										✓	5	CE,CB,CCC,RCM,ENEC,SAA	76
	11-80W	LF-GLDxxxYE		✓							IP20	✓	5	CE,CB,RCM,SAA	77
100-277Vac	34-44W	LF-GSD045YB			✓	✓			✓	✓	IP20	✓	7	ENEC,CE,CB,RCM,SAA,DALI2.0	40
	14-40W	LF-GSPxxxYD		For LED emergency light								✓	3	UL,CE	54
	5/7/10/12W	LF-GSP012YH		For LED emergency light					✓	✓		✓	5	UL,FCC,CE	55
	5/7/10/12W	LF-GSPxxxYG		For LED emergency light					✓			✓	5	UL,FCC,CE	56
	11-65W	LF-GLDxxxYS		✓								✓	5	FCC,UL	78

Indoor: LED high bay light, flood light, etc.







220-240Vac	100-240W	LF-FHBxxxYDIV		✓					✓	✓	IP65	✓	5	ENEC,CE,CB,RCM,SAA,CCC	28
	100-240W	LF-FHBxxxYEIV							✓		IP65	✓	5	ENEC,CE,CB,RCM,SAA,CCC	28
	100-240W	LF-FHBxxxYJIV		✓					✓		IP65	✓	5	ENEC,CE,CB,RCM,SAA,CCC	28
100-277Vac	100-240W	LF-FHBxxxYAIV		✓					✓	✓	IP65	✓	5	ENEC,CE,CB,RCM,SAA,CCC,FCC,UL	27
	100-240W	LF-FHBxxxYBIV							✓		IP65	✓	5	ENEC,CE,CB,RCM,SAA,CCC,FCC,UL	27
	100-240W	LF-FHBxxxYCIV		✓					✓		IP65	✓	5	ENEC,CE,CB,RCM,SAA,CCC,FCC,UL	27

Outdoor: LED street light, etc.





220-240Vac	10-75W	LF-EANxxx									IP67	✓	5	CE,CB,RCM,SAA,CCC	21
------------	--------	-----------	--	--	--	--	--	--	--	--	------	---	---	-------------------	----

Input Voltage	Output Power	Model	Picture	Dimming Mode				Tunable White	Adjustable Current	12V Auxiliary Power Supply	IP Rating	Flicker Free	Warranty yrs	Certification	Page
				0-10V, PWM & Rx	DALI	Push	Triac								
220-240Vac	25-100W	LF-GOExxxYE(E)/YF(E)		YF(E)				√		IP67		5	ENEC,CE,CB,RCM,SAA,CCC	22	
	10-50W	LF-GSDxxxYH			√	√		√		IP67	√	5	ENEC,CE,CB,RCM,SAA,CCC,DALI2.0	43	
100-277Vac	30-75W	LF-GOExxxYE/YF		YF				√		IP67	√	5	ENEC,CE,CB,RCM,SAA,CCC,FCC,UL	23	
	110-320W	LF-GOExxxYE/YF		YF				√		IP67	√	5	ENEC,CE,CB,RCM,SAA,CCC,FCC,UL	24	
	110-320W	LF-GOExxxYJ/YK		0-10V&PWM					Intelligent Adaptive Constant Power	YK	IP67	√	5	ENEC,CE,CB,RCM,SAA,CCC,FCC,UL	25
	110-320W	LF-GOExxxYH			√				Intelligent Adaptive Constant Power	Optional	IP67	√	5	ENEC,CE,CB,RCM,SAA,CCC,FCC,UL,DALI2.0	26

LED Strip

220-240Vac	75-150W	LF-GSDxxxYVxxA			√	√		√	Adjustable Voltage		IP20	√	5	ENEC,CE,CB,RCM,SAA,CCC,DALI2.0	45
	75-150W	LF-GSDxxxYVxxB		√	√	√			Adjustable Voltage		IP20	√	5	ENEC,CE,CB,RCM,SAA,CCC,DALI2.0	46
	75-150W	LF-GATxxx					√		Adjustable Voltage		IP20	√	5	ENEC,CE,CB,RCM,SAA,CCC	51
	75-150W	LF-GDExxxYV		√					Adjustable Voltage		IP20	√	5	ENEC,CE,CB,RCM,SAA,CCC	52
	100-240W	LF-KADxxx12/24			√	√		√	Adjustable Voltage		IP67	√	5	ENEC,CE,CB,RCM,SAA,CCC,DALI2.0	44
100-277Vac	75-250W	LF-GOExxxYV						Adjustable Voltage		IP67	√	5	ENEC,CE,CB,RCM,SAA,CCC,FCC,UL	29	
100-240Vac	360-400W	LF-KANxxx						Adjustable Voltage		IP42	√	3	CE,CCC	30	

Accessory

DALI Converter(AC Power Supply)	LF-SCD010A		0-10V								IP20		5	DALI2.0,CE	41
DALI Converter(DC Power Supply)	LF-SCD010B		0-10V								IP67		5	CE	41
DALI Converter(No Additional Power)	LF-SCD010C		PWM								IP67	√	5	CE	41
DALI Bus Power Supply	LF-GSD005YD										IP20		5	DALI2.0,CE	42



High Power LED Driver

**Redefine High
Power LED Driver**

Street Lighting Non-Dimmable Series

LF-EANxxx*10-75W

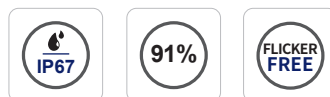

Feature

- High efficiency up to 91%
- THD \leq 10%
- Small size, easy for installation inside the light
- Two kinds of cord optional: low smoke halogen free cord or rubber cord
- Surge protection: L-N: 4KV, L/N-GND: 6KV
- Suitable for Class I & II light fixtures



Parameter

Model	Output Power (Max)	Output Voltage (V)	Output Current (A)	Efficiency (full load)	PF
LF-EAN010	10W	14-24	0.20-0.35	85%(230Vac)	0.95(230Vac)
LF-EAN015	15W	33-42	0.20-0.40	88%(230Vac)	0.95(230Vac)
LF-EAN020	20W	33-42	0.35-0.50	88%(230Vac)	0.95(230Vac)
LF-EAN030	30W	33-42	0.50-0.75	90%(230Vac)	0.95(230Vac)
LF-EAN040	40W	33-42	0.80-1.00	91%(230Vac)	0.95(230Vac)
LF-EAN050	50W	33-42	1.00-1.20	90%(230Vac)	0.95(230Vac)
LF-EAN060	60W	33-42	1.20-1.50	91%(230Vac)	0.95(230Vac)
LF-EAN075	75W	33-42	1.50-1.80	91%(230Vac)	0.95(230Vac)

Specification

Item	Parameter
Operating Voltage	220-240Vac; 180-280Vdc
Operating Voltage Limit	180-305Vac; 280-374Vdc
THD	\leq 10%
Ta	-30°C ~ +60°C
Tc	90°C
IP Rating	IP67
Protection Characteristics	Open circuit, short circuit, over temperature, over voltage, surge protection
Withstanding Voltage	I/P-O/P: 3.75KVac

Dimensions

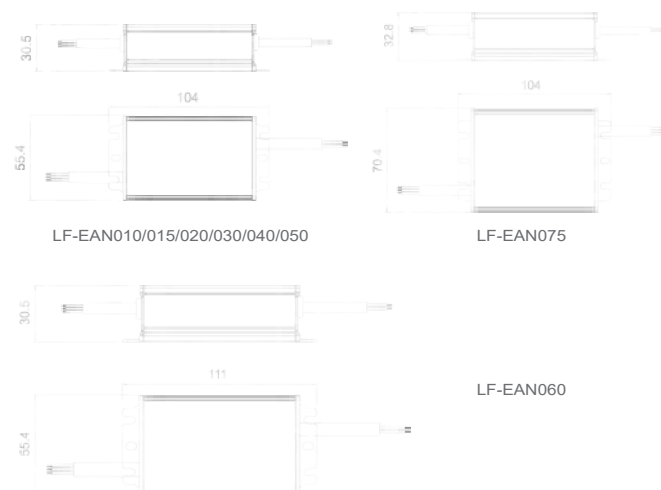

Street Lighting Conventional Series

LF-GOExxxYE(E)/YF(E)*25-100W



Feature

- YE: non-dimmable; YF: 3-in-1 dimming: 0-10V/PWM/Rx
- High efficiency up to 90%
- Output current adjustable via the potentiometer on the side
- Surge protection: L/N: 6KV, L/N-GND: 10KV



Parameter

Model	Output Power (Max)	Output Voltage (V)	Output Current (A)	Efficiency (full load)	PF	Warranty Tc
LF-GOE025YE(E)/YF(E)	25W	30-54	0.35-0.52	88%(230Vac)	0.95(230Vac)	\leq 80°C
LF-GOE040YE(E)/YF(E)	40W	30-54	0.35-1.2	88%(230Vac)	0.95(230Vac)	\leq 80°C
LF-GOE060YE(E)/YF(E)	60W	30-54	0.6-1.7	88%(230Vac)	0.95(230Vac)	\leq 79°C
LF-GOE075YE(E)/YF(E)	75W	30-54	1.2-2.1	90%(230Vac)	0.95(230Vac)	\leq 75°C
LF-GOE100YE(E)/YF(E)	100W	30-54	1.6-2.8	90%(230Vac)	0.95(230Vac)	\leq 75°C

Specification

Item	Parameter
Operating Voltage	220-240Vac; 311-339Vdc
Operating Voltage Limit	180-264Vac; 280-374Vdc
THD	\leq 15%
Ta	-40°C ~ +60°C
Tc	90°C
IP Rating	IP67
Protection Characteristics	Open circuit, short circuit, over temperature, over voltage, surge protection
Withstanding Voltage	I/P-O/P: 3.75KVac I/P-FG: 1.5KVac O/P-FG: 0.5KVac

Dimensions

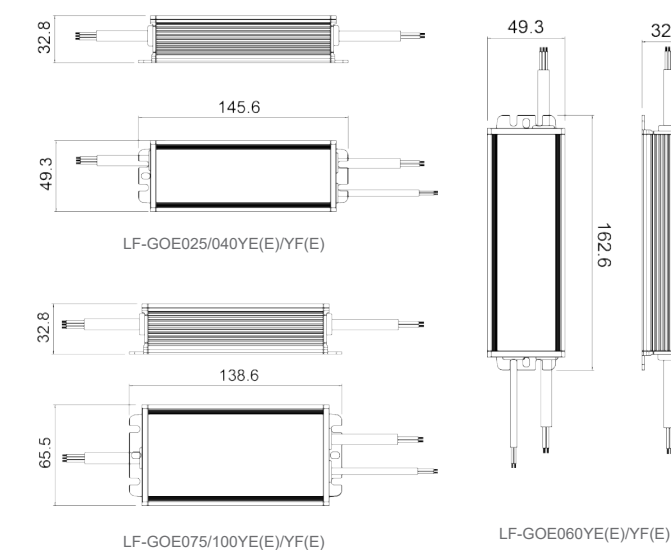

Street Lighting Conventional Series

LF-GOExxxYE/YF*30-75W

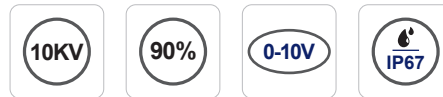

Feature

- YE: non-dimmable; YF: 3-in-1 dimming: 0-10V/PWM/Rx
- High efficiency up to 90%
- Output current adjustable via the potentiometer on the side
- Surge protection: L/N: 6KV, L/N-GND: 10KV



Parameter

Model	Output Power (Max)	Output Voltage (V)	Output Current (A)	Efficiency (full load)	PF	Warranty Tc
LF-GOE030YE/YF	30W	30-54	0.35-0.85	88%(230Vac)	0.95(230Vac)	≤80°C
LF-GOE050YE/YF	50W	30-54	0.6-1.4	88%(230Vac)	0.95(230Vac)	≤79°C
LF-GOE060YE/YF	60W	30-54	1.1-1.7	90%(230Vac)	0.95(230Vac)	≤75°C
LF-GOE075YE/YF	75W	30-54	1.35-2.1	90%(230Vac)	0.95(230Vac)	≤75°C

Specification

Item	Parameter
• Operating Voltage	100-277Vac; 141-391Vdc
• Operating Voltage Limit	90-305Vac; 127-431Vdc
• THD	≤15%
• Ta	-40°C~ +60°C
• Tc	90°C
• IP Rating	IP67
• Protection Characteristics	Open circuit, short circuit, over temperature, over voltage, surge protection
• Withstanding Voltage	I/P-O/P: 3.75KVac I/P-FG: 1.5KVac O/P-FG: 0.5KVac

Dimensions

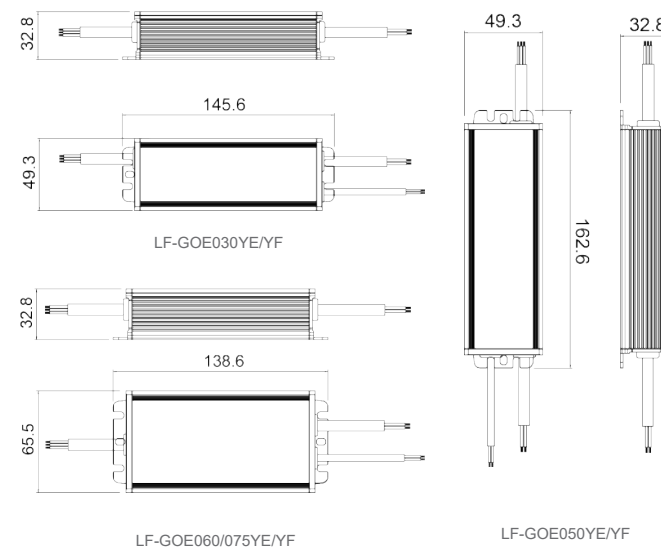

Street Lighting Conventional Series

LF-GOExxxYE/YF*110-320W



Feature

- YE: non-dimmable; YF: 3-in-1 dimming: 0-10V/PWM/Rx
- High efficiency up to 94%
- Two-stage flicker free
- Output current adjustable via the potentiometer
- Surge protection: L/N: 6KV, L/N-GND: 10KV



Parameter

Model	Output Power (Max)	Output Voltage (V)	Output Current (A)	Efficiency (full load)	PF	Warranty Tc
LF-GOE110YE/YF	110W	27-56/75-142	1.5-3/0.7-1.05	91%(230Vac)	0.95(230Vac)	≤85.5°C
LF-GOE150YE/YF	150W	27-56/120-214	1.8-4.2/0.7-1.05	92%(230Vac)	0.95(230Vac)	≤85.5°C
LF-GOE200YE/YF	200W	27-56/143-285	3-5.5/0.7-1.05	93%(230Vac)	0.95(230Vac)	≤86°C
LF-GOE240YE/YF	240W	27-56/178-342	3.5-6.7/0.7-1.05	93%(230Vac)	0.95(230Vac)	≤78°C
LF-GOE320YE/YF	320W	27-56	4-8.9	94%(230Vac)	0.95(230Vac)	≤75°C

Specification

Item	Parameter
• Operating Voltage	100-277Vac; 141-391Vdc
• Operating Voltage Limit	90-305Vac; 127-431Vdc
• THD	≤10%
• Ta	-40°C~ +60°C (200-277Vac) -40°C~ +50°C (100-200Vac)
• Tc	90°C
• IP Rating	IP67
• Protection Characteristics	Open circuit, short circuit, over temperature, over voltage, surge protection
• Withstanding Voltage	I/P-O/P: 3.75KVac I/P-FG: 1.5KVac O/P-FG: 0.5KVac

Dimensions

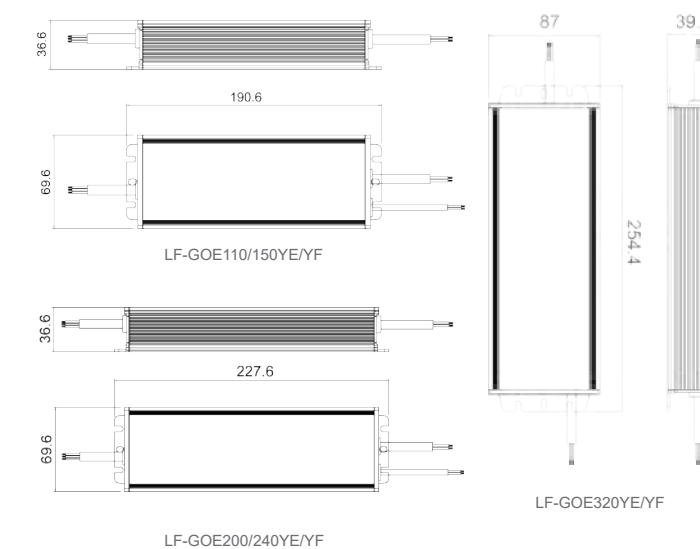

Street Lighting Programmable Series

LF-GOExxxYJ/YK*110-320W



Feature

- YJ: 0-10V/PWM dimming;
YK: 0-10V/PWM dimming+12V/200mA auxiliary power supply
- High efficiency up to 94%
- Two-stage flicker free
- Intelligent adaptive constant power
- 7 sections of timing dimming, output lumen compensation
- Surge protection: L/N: 6KV, L/N-GND: 10KV



Parameter

Model	Output Power (Max)	Output Voltage (V)	Output Current (A)	Efficiency (full load)	PF	Warranty Tc
LF-GOE110YJ/YK	110W	27-56/75-142	1.5-3/0.7-1.05	91%(230Vac)	0.95(230Vac)	≤85.5°C
LF-GOE150YJ/YK	150W	27-56/120-214	1.8-4.2/0.7-1.05	92%(230Vac)	0.95(230Vac)	≤85.5°C
LF-GOE200YJ/YK	200W	27-56/143-285	3-5.5/0.7-1.05	93%(230Vac)	0.95(230Vac)	≤86°C
LF-GOE240YJ/YK	240W	27-56/178-342	3.5-6.7/0.7-1.05	93%(230Vac)	0.95(230Vac)	≤78°C
LF-GOE320YJ/YK	320W	27-56	4-8.9	94%(230Vac)	0.95(230Vac)	≤75°C

Specification

Item	Parameter
• Operating Voltage	100-277Vac; 141-391Vdc
• Operating Voltage Limit	90-305Vac; 127-431Vdc
• THD	≤10%
• Ta	-40°C~ +60°C(200-277Vac) -40°C~ +50°C(100-200Vac)
• Tc	90°C
• IP Rating	IP67
• Protection Characteristics	Open circuit, short circuit, over temperature, over voltage, surge protection
• Withstanding Voltage	I/P-O/P: 3.75KVac I/P-FG: 1.5KVac O/P-FG: 0.5KVac

Dimensions

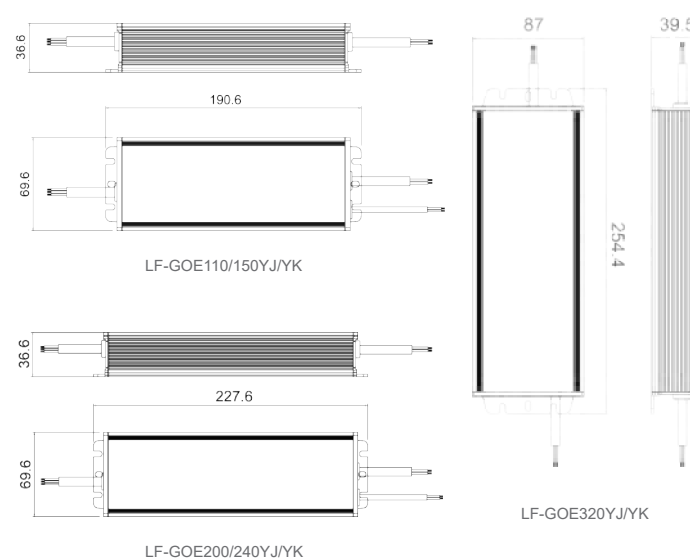

Street Lighting DALI Dimming Series

LF-GOExxxYH*110-320W



Feature

- DALI dimming
- High efficiency up to 94%
- Two-stage flicker free
- Intelligent adaptive constant power
- 12V auxiliary power supply (optional)
- Surge protection: L/N: 6KV, L/N-GND: 10KV



Parameter

Model	Output Power (Max)	Output Voltage (V)	Output Current (A)	Efficiency (full load)	PF	Warranty Tc
LF-GOE110YH	110W	27-56/75-142	1.5-3/0.7-1.05	91%(230Vac)	0.95(230Vac)	≤85.5°C
LF-GOE150YH	150W	27-56/120-214	1.8-4.2/0.7-1.05	92%(230Vac)	0.95(230Vac)	≤85.5°C
LF-GOE200YH	200W	27-56/143-285	3-5.5/0.7-1.05	93%(230Vac)	0.95(230Vac)	≤86°C
LF-GOE240YH	240W	27-56/178-342	3.5-6.7/0.7-1.05	93%(230Vac)	0.95(230Vac)	≤78°C
LF-GOE320YH	320W	27-56	4-8.9	94%(230Vac)	0.95(230Vac)	≤75°C

Specification

Item	Parameter
• Operating Voltage	100-277Vac; 141-391Vdc
• Operating Voltage Limit	90-305Vac; 127-431Vdc
• THD	≤10%
• Ta	-40°C~ +60°C (200-277Vac) -40°C~ +50°C (100-200Vac)
• Tc	90°C
• IP Rating	IP67
• Protection Characteristics	Open circuit, short circuit, over temperature, over voltage, surge protection
• Withstanding Voltage	I/P-O/P: 3.75KVac I/P-FG: 1.5KVac O/P-FG: 0.5KVac

Dimensions

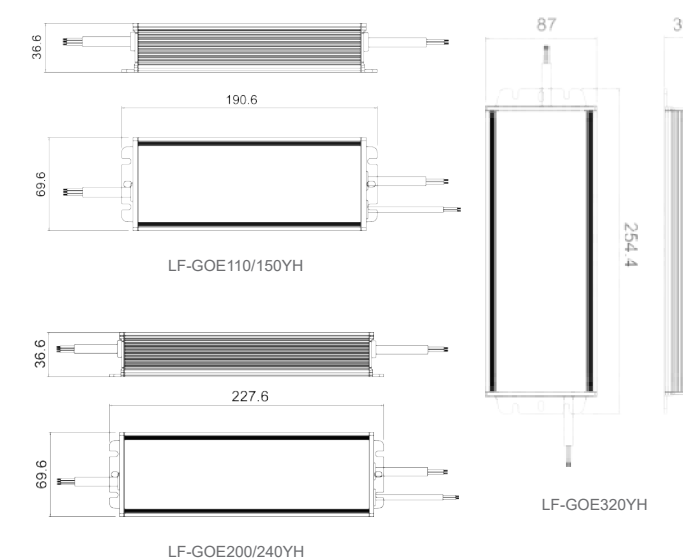

100-277Vac UFO GEN.IV Series

LF-FHBxxxYA/YB/YC IV*100-240W

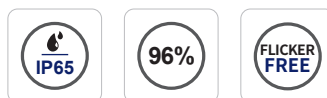

Feature

- YB: non-dimmable; YC: 3-in-1 dimming;
YA: 3-in-1 dimming+12V auxiliary power supply
- Dim to off, after-glow free
- High efficiency up to 96%
- Two-stage flicker free
- Output current adjustable via the potentiometer or via the DIP switch (optional)
- Residual voltage less than 1.5KV
- Surge protection: L-N: 4KV; L/N-GND: 6KV



Parameter

Model	Output Power (Max)	Output Voltage (V)	Output Current (A)	Efficiency (full load)	PF
LF-FHB100YA/YB/YC IV	100W	180-260	0.25-0.40	95%(230Vac)	0.95(230Vac)
LF-FHB120YA/YB/YC IV	120W	180-260	0.30-0.50	95%(230Vac)	0.95(230Vac)
LF-FHB150YA/YB/YC IV	150W	180-260	0.50-0.75	95%(230Vac)	0.95(230Vac)
LF-FHB200YA/YB/YC IV	200W	180-260	0.65-0.90	96%(230Vac)	0.95(230Vac)
LF-FHB240YA/YB/YC IV	240W	180-260	0.75-1.10	96%(230Vac)	0.95(230Vac)

Specification

Item	Parameter
• Operating Voltage	100-277Vac; 141-391Vdc
• Operating Voltage Limit	90-305Vac; 127-431Vdc
• THD	≤15%
• Ta	-40°C~ +60°C
• Tc	90°C
• IP Rating	IP65
• Protection Characteristics	Open circuit, short circuit, over temperature, over voltage, surge protection
• Withstanding Voltage	I/P-FG: 1.5KVac

Dimensions

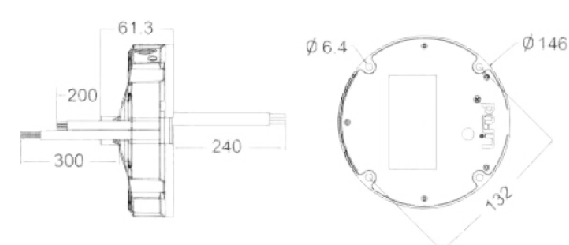

LF-FHB200/240YA/YB/YC IV

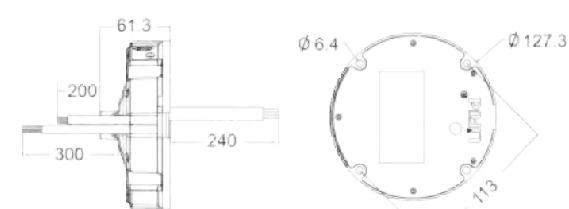

LF-FHB100/120/150YA/YB/YC IV

220-240Vac UFO GEN.IV Series

LF-FHBxxxYD/YE/YJ IV*80-240W

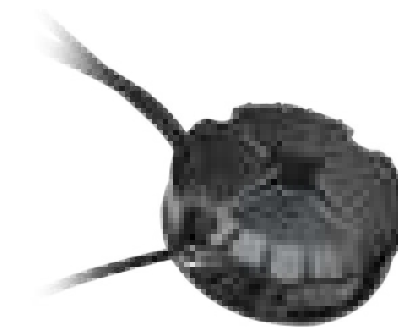
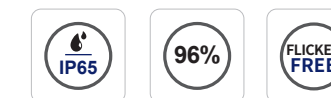

Feature

- YE: non-dimmable; YJ: 3-in-1 dimming;
YD: 3-in-1 dimming+12V auxiliary power supply
- Dim to off, after-glow free
- High efficiency up to 96%
- Two-stage flicker free
- Output current adjustable via the potentiometer or via the DIP switch (optional)
- Residual voltage less than 1.5KV
- Surge protection: L-N: 4KV; L/N-GND: 6KV



Parameter

Model	Output Power (Max)	Output Voltage (V)	Output Current (A)	Efficiency (full load)	PF	Warranty Tc
LF-FHB080YD/YE/YJ IV	80W	180-260	0.20-0.35	93%(230Vac)	0.95(230Vac)	≤80°C
LF-FHB120YD/YE/YJ IV	120W	180-260	0.30-0.50	95%(230Vac)	0.95(230Vac)	≤82°C
LF-FHB150YD/YE/YJ IV	150W	180-260	0.50-0.75	95%(230Vac)	0.95(230Vac)	≤81°C
LF-FHB200YD/YE/YJ IV	200W	180-260	0.65-0.90	96%(230Vac)	0.95(230Vac)	≤79°C
LF-FHB240YD/YE/YJ IV	240W	180-260	0.75-1.10	96%(230Vac)	0.95(230Vac)	≤83°C

Specification

Item	Parameter
• Operating Voltage	220-240Vac; 176-340Vdc
• Operating Voltage Limit	176-305Vac; 280-374Vdc
• THD	≤15%
• Ta	-40°C~ +60°C
• Tc	90°C
• IP Rating	IP65
• Protection Characteristics	Open circuit, short circuit, over temperature, over voltage, surge protection
• Withstanding Voltage	I/P-FG: 1.5KVac

Dimensions

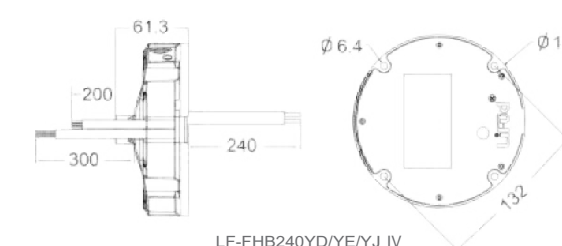

LF-FHB240YD/YE/YJ IV

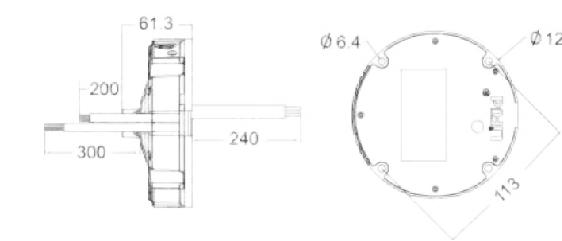

LF-FHB080/120/150/200YD/YE/YJ IV

Outdoor Constant Voltage Series

LF-GOExxxYV*75-250W

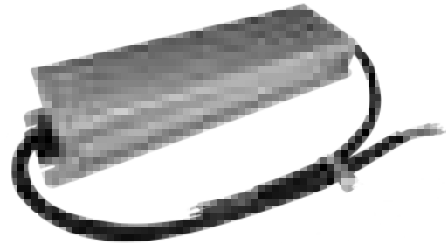

Feature

- Flicker free
- High efficiency up to 93%
- Output voltage adjustable via the potentiometer on the bottom
- Surge protection: L-N: 6KV; L/N-GND: 8KV



Parameter

Model	Output Power (Max)	Output Voltage (V)	Output Current (A)	Efficiency (full load)	PF	Warranty Tc
LF-GOE075YV012A	75W	12	0.24-6.25	87%(230Vac)	0.95(230Vac)	≤75°C
LF-GOE075YV024A	75W	24	0.24-3.12	87%(230Vac)	0.95(230Vac)	≤77°C
LF-GOE100YV012A	100W	12	0.24-8.34	90%(230Vac)	0.95(230Vac)	≤75°C
LF-GOE100YV024A	100W	24	0.24-4.17	90%(230Vac)	0.95(230Vac)	≤76°C
LF-GOE150YV012A	138W	12	0.4-11.5	93%(230Vac)	0.95(230Vac)	≤75°C
LF-GOE150YV024A	150W	24	0.4-6.25	93%(230Vac)	0.95(230Vac)	≤74°C
LF-GOE200YV012A	200W	12	0.4-16.67	93%(230Vac)	0.95(230Vac)	≤75°C
LF-GOE200YV024A	200W	24	0.4-8.34	93%(230Vac)	0.95(230Vac)	≤74°C
LF-GOE250YV024A	250W	24	0.4-10.42	93%(230Vac)	0.95(230Vac)	≤72°C

Specification

Item	Parameter
• Operating Voltage	100-277Vac; 141-391Vdc
• Operating Voltage Limit	90-305Vac; 127-431Vdc
• THD	<15%
• Ta	-40°C~ +60°C
• Tc	90°C
• IP Rating	IP67
• Protection Characteristics	Open circuit, short circuit, over temperature, over voltage, surge protection
• Withstanding Voltage	I/P-O/P: 3.75KVac I/P-FG: 1.5KVac O/P-FG: 0.5KVac

Dimensions

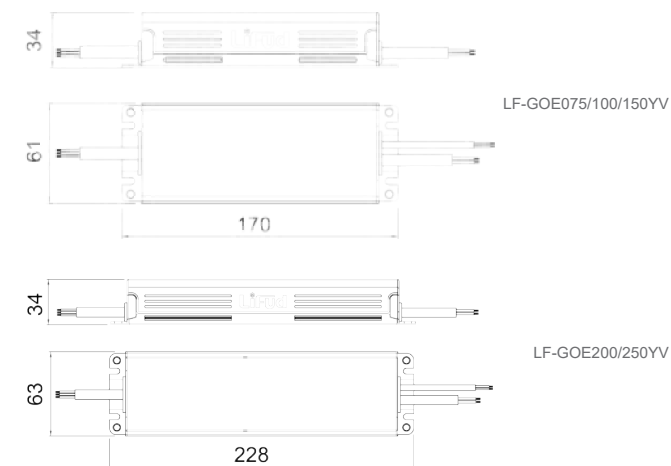

400W Constant Voltage Series

LF-KANxxx*360-400W



Feature

- High efficiency of 94.5%, less heat dissipation, more reliable
- Aluminum casing & semi-potted interior design against rain splash
- Doubled-side PCB, firm welding
- PF>0.95, THD<10%, less interference
- Output voltage adjustable via the potentiometer
- Cooled by free air convection



Parameter

Model	Output Power (Max)	Output Voltage (V)	Output Current (A)	Efficiency (full load)	PF	Warranty Tc
LF-KAN400-8300-48	400W	48	0-8.3	94%(230Vac)	0.90(230Vac)	90°C
LF-KAN400-16700-24	400W	24	0-16.7	93%(230Vac)	0.90(230Vac)	90°C
LF-KAN400-30000-12	360W	12	0-30	92%(230Vac)	0.90(230Vac)	90°C

Specification

Item	Parameter
• Operating Voltage	100-240Vac
• Operating Voltage Limit	90-264Vac
• THD	<10%
• Ta	-30°C~+70°C
• Tc	90°C
• IP Rating	IP42
• Protection Characteristics	Short circuit, over load, over voltage, over temperature
• Withstanding Voltage	I/P-O/P: 3.75KVac I-P-FG: 1.5KVac

Dimensions

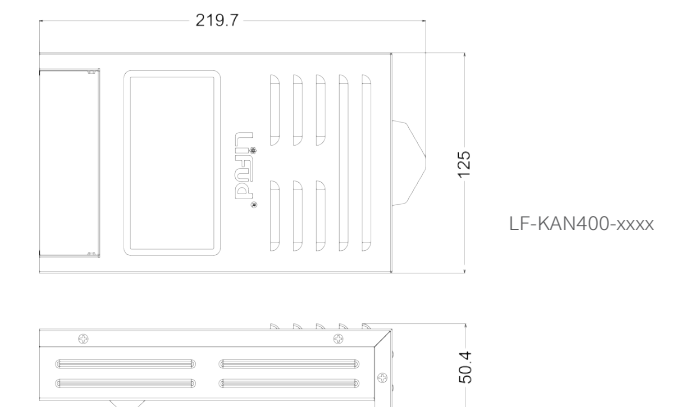



Intelligent LED Driver

- Simple Installation
- Simple Usage
- Simple Maintenance
- Smooth Dimming
- Exceptional Dimming Accuracy (3%)
- Ultimate Dimming Depth (0.1%)

Intelligent Lighting System

DALI Control System·Regional Scene

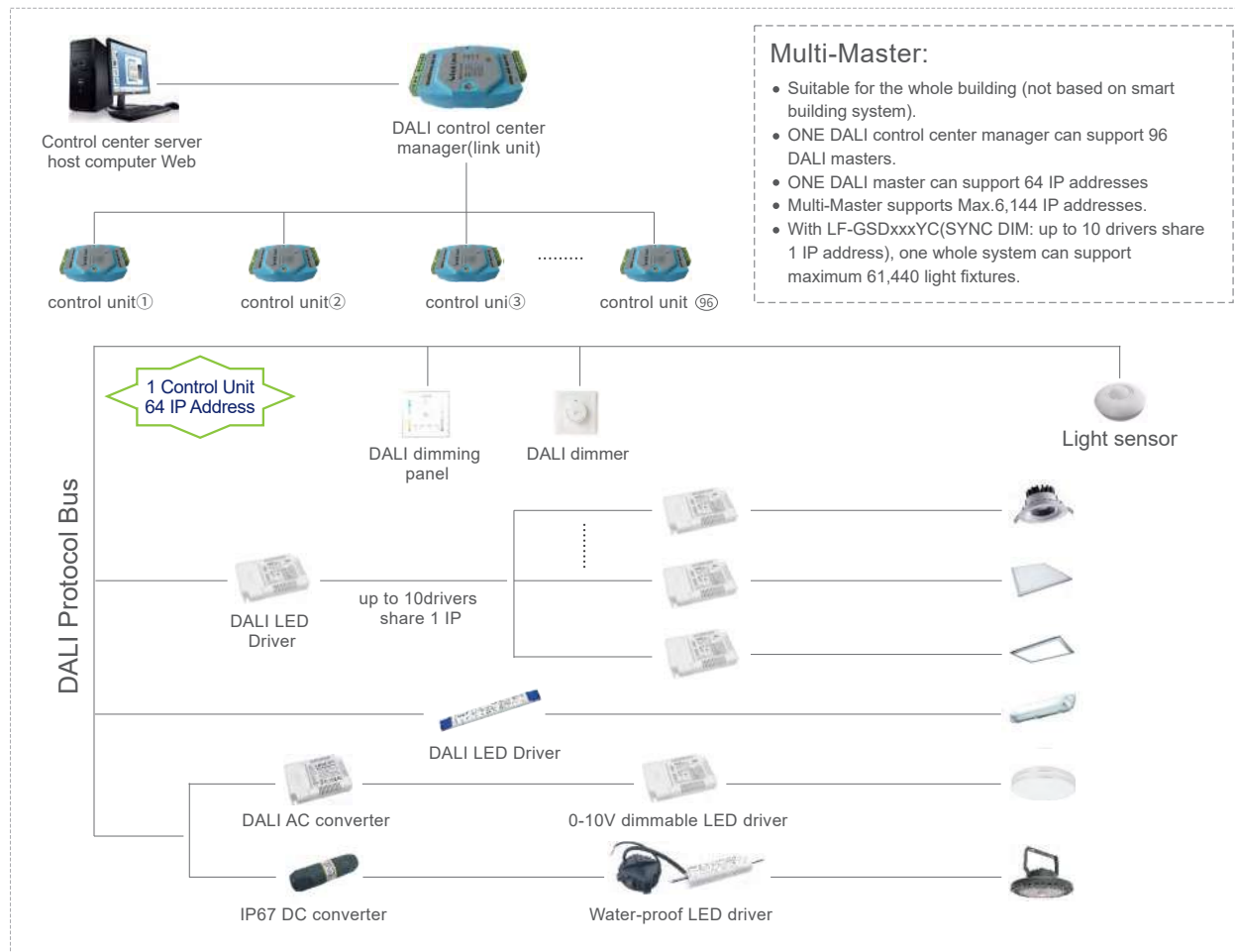

Digital

Addressable

Lighting

Interface

Brief introduction:

DALI is a dedicated data transmission protocol for digital lighting control, defining the digital communication method between lighting appliances (power supply of light fixtures) and system control devices (such as lighting controller and light sensor)

System:

Up to 64 addressable (luminaires) drivers on one DALI bus (independent address)

Up to 16 lighting groups (grouping address)

Up to 16 lighting scenes (pre-set scene)

Intelligent Lighting System

DALI Product List

Product Name	Picture	Model	Specifications	Certificate	L*W*H (mm)
DALI System PC Software (DALI control center)		LF-SCD000B	DALI large-scale control center PC software package		
DALI Control Center Manager (link unit)		LF-SCD001B	1. Integrated control: 96 masters*64 nodes/lamps 2. It works with the LF-SCD000B 3. DALI system, network's max.wire length 1200m	Conform to CE	117*72*26
DALI Control Center Master (control unit)		LF-SCD002B	DALI Master with LF-SCD000B, DALI system, max.96 pcs of control center master in parallel(N≤96)	Conform to CE	117*72*26
DALI Master (single version)		LF-SCD000A	1. Single version, 1 master can control 64 lamps/devices 2. Field management software is for free (non-joint control)	Conform to CE	100*70*35
DALI Master (WIFI version)		LF-SCD000C	1. Single version, supporting 64 individual addresses(64 pcs LED lights) 2. WIFI joint control(via PAD or mobile) 3. DALI field management software is for free	Conform to CE	122*70*35
DALI Bus Power Supply		LF-GSD005YD	Power on all devices on DALI bus AC100-240V,DC16V±5%	Conform to CE	116*36*67
Light Sensor (human motion detection+light measurement sensor)		LF-SCD050A	2 in 1 sensor(light induction+human motion detection), surface mounted installation, self-defined DALI protocol, powered by DALI bus	Conform to CE	Φ90*38
DALI Dimmer (rotary)		LF-SCD020B	Realize the on/off and dimming functions of 0-63 individual addresses, 0-15 group addresses, 0-15 scenes and broadcast via a DIP switch	Conform to CE	86*86*34
DALI Dimming Panel (touch screen)		LF-SCD030A	Single lamp, group, scene, broadcast address can be turned on/off or be dimmed. It can be set by the DIP on the switch. TFT display screen, powered by DC24V	Conform to CE	86*86*34
Waterproof DALI Converter		LF-SCD010B/C	Convert the light fixtures (highbay light, tri-proof light, street light and etc.) with 0-10V or PWM dimming functions to DALI dimmable light fixtures; Version B: DC power supply; Version C: DALI bus power supply	Conform to CE	111*30
DALI Signal Converter		LF-SCD010A	AC100-277V DC0-10V 20mA, convert DALI signal to 0-10V or PWM dimming signal, equip conventional dimmable driver with DALI dimming function	Conform to CE	103.8*67.8*25.4

DALI-2 DT8 Tunable White Series

LF-GSDxxxYK/YG*12-50W



Feature

- DALI + Push dimming
- Output current adjustable via the DIP switch (50mA a step)
- Smooth dimming, optional logarithmic or linear dimming curve
- Flicker free
- CCT range: 2000-7000K
- Dimming range: 0%-100%; dimming depth: 1%
- Suitable for Class II light fixtures



Parameter

Model	Output Power (Max)	Output Voltage (V)	Output Current (mA)	Efficiency (full load)	PF	Warranty Tc
LF-GSD012YK	12W	9-42	100-350	83%(230Vac)	0.90(230Vac)	≤86°C
LF-GSD020YK	20W	9-42	350-700	85%(230Vac)	0.95(230Vac)	≤83°C
LF-GSD020YG	20W	20-42	250-500	85%(230Vac)	0.93(230Vac)	≤84°C
LF-GSD040YG	40W	20-42	550-1050	87%(230Vac)	0.95(230Vac)	≤77°C
LF-GSD050YG	50W	20-42	900-1200	89% 230Vac)	0.95(230Vac)	≤78°C

Specification

Item	Parameter
• Operating Voltage	220-240Vac; 310-340Vdc
• Operating Voltage Limit	198-264Vac; 280-374Vdc
• THD	≤15%
• Ta	-30°C ~ +45°C
• Tc	90°C
• IP Rating	IP20
• Protection Characteristics	Open circuit, short circuit
• Withstanding Voltage	I/P-O/P: 3.75kV 5mA 60S

Dimensions

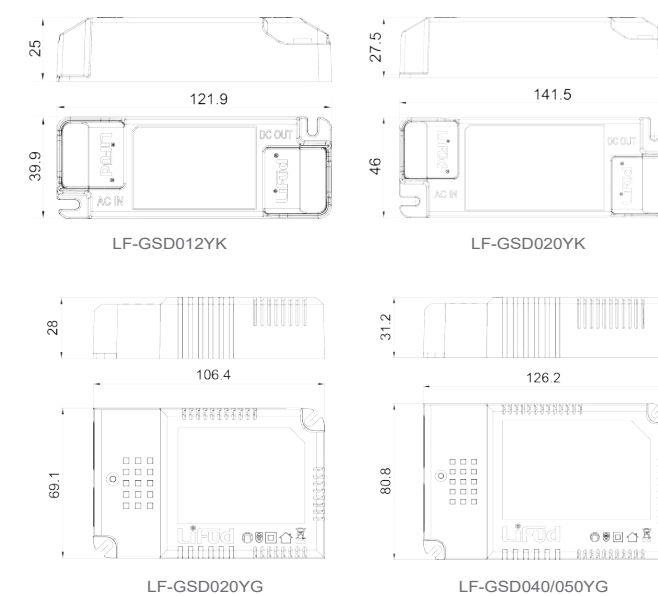

DALI-2 DT6 Dimming Series

LF-GSDxxxPF*6-40W



Feature

- DALI + Push dimming
- Consistent luminance, current tolerance no more than 3% in different batches
- Output current adjustable via the DIP switch (50mA a step)
- Smooth dimming, optional logarithmic or linear dimming curve
- Flicker free, percent flicker less than 1%
- Dimming range: 0%-100%; dimming depth: 1%
- Suitable for Class II light fixtures



Parameter

Model	Output Power (Max)	Output Voltage (V)	Output Current (mA)	Efficiency (full load)	PF	Warranty Tc
LF-GSD012PF	12W	20-42	150-400	82%(230Vac)	0.90(230Vac)	≤86°C
LF-GSD012PF	12W	20-36	350	82%(230Vac)	0.92(230Vac)	≤86°C
LF-GSD012PF	12W	20-32	400	82%(230Vac)	0.93(230Vac)	≤86°C
LF-GSD020PF	20W	20-42	250-500	85%(230Vac)	0.95(230Vac)	≤86°C
LF-GSD030PF	30W	20-42	400-750	85%(230Vac)	0.95(230Vac)	≤78°C
LF-GSD040PF	40W	20-42	550-1000	87%(230Vac)	0.95(230Vac)	≤83°C
LF-GSD040PF	40W	20-40	1000	87%(230Vac)	0.95(230Vac)	≤83°C
LF-GSD040PF	40W	20-38	1050	87%(230Vac)	0.95(230Vac)	≤83°C

Specification

Item	Parameter
• Operating Voltage	220-240Vac; 310-340Vdc
• Operating Voltage Limit	198-264Vac; 280-374Vdc
• THD	≤15%
• Ta	-30°C ~ +45°C
• Tc	90°C
• IP Rating	IP20
• Protection Characteristics	Open circuit, short circuit
• Withstanding Voltage	I/P-O/P: 3.75kV 5mA 60S

Dimensions

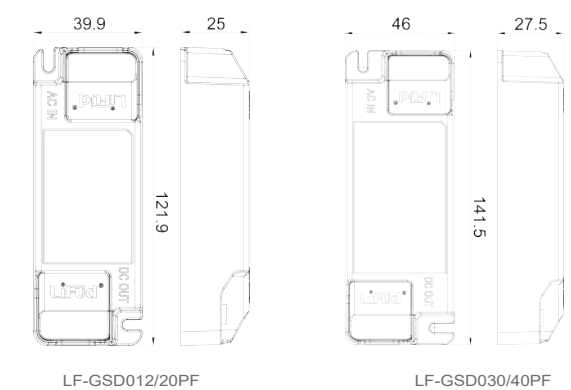

DALI-2 DT6 Dimming Series

LF-AADxxx*4-40W



Feature

- DALI + Push dimming
- Consistent luminance, current tolerance no more than 3% in different batches
- Output current adjustable via the DIP switch (50mA a step)
- Smooth dimming, optional logarithmic or linear dimming curve
- Flicker free, percent flicker less than 1%
- Dimming range: 0%-100%; dimming depth: 0.1%
- Suitable for Class II light fixtures



Parameter

Model	Output Power (Max)	Output Voltage (V)	Output Current (mA)	Efficiency (full load)	PF	Warranty Tc
LF-AAD008-0350-42	8W	9-42	100-350	76%(230Vac)	0.90(230Vac)	≤86°C
LF-AAD008-0700-12	8W	2-12	350-700	76%(230Vac)	0.90(230Vac)	≤86°C
LF-AAD012-0400-42	12W	9-42	150-400	82%(230Vac)	0.90(230Vac)	≤86°C
LF-AAD020-0500-42	20W	9-42	250-500	85%(230Vac)	0.95(230Vac)	≤86°C
LF-AAD030-0750-42	30W	9-42	400-750	85%(230Vac)	0.95(230Vac)	≤78°C
LF-AAD040-1050-42	40W	9-42	550-1050	87%(230Vac)	0.95(230Vac)	≤83°C

Specification

Item	Parameter
• Operating Voltage	220-240Vac; 310-340Vdc
• Operating Voltage Limit	198-264Vac; 280-374Vdc
• THD	≤15%
• Ta	-30°C ~ +45°C
• Tc	90°C
• IP Rating	IP20
• Protection Characteristics	Open circuit, short circuit
• Withstanding Voltage	I/P-O/P: 3.75kV 5mA 60S

Dimensions

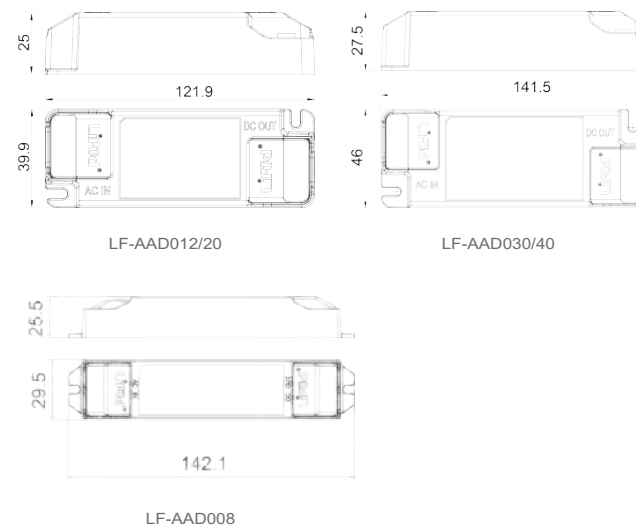

DALI-2 5-in-1 Dimming Series

LF-GSDxxxYC*11-60W



Feature

- Five dimming options: DALI/Push/0-10V/PWM/Rx
- Up to 10 drivers can be dimmed synchronously and share 1 IP address
- Smooth dimming, optional logarithmic or linear dimming curve
- Output current adjustable via the DIP switch (50mA a step)
- Flicker free
- Dimming range: 0%-100%; dimming depth: 0.1%
- Suitable for Class I & II light fixtures



Parameter

Model	Output Power (Max)	Output Voltage (V)	Output Current (mA)	Efficiency (full load)	PF	Warranty Tc
LF-GSD020YC	20W	25-42	250-500	86%(230Vac)	0.95(230Vac)	≤73°C
LF-GSD040YC	40W	25-42	550-1050	89%(230Vac)	0.95(230Vac)	≤80°C
LF-GSD060YC	60W	25-42	1100-1500	89%(230Vac)	0.95(230Vac)	≤83°C

Specification

Item	Parameter
• Operating Voltage	220-240Vac; 310-340Vdc
• Operating Voltage Limit	198-264Vac; 280-374Vdc
• THD	≤15
• Ta	-30°C~+50°C
• Tc	90°C
• IP Rating	IP20
• Protection Characteristics	Open circuit, short circuit
• Withstanding Voltage	I/P-O/P: 3.75kV 5mA 60S

Dimensions

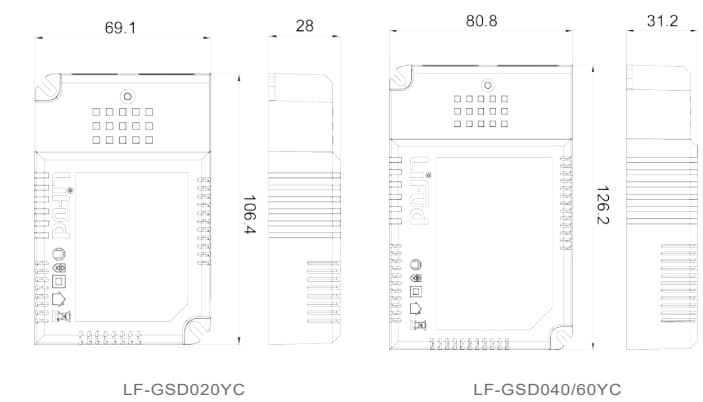

DALI-2 220-240Vac Dimming Series

LF-GSDxxxYE*4-80W

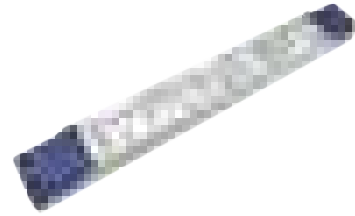

Feature

- DALI + Push dimming
- Smooth dimming, optional logarithmic or linear dimming curve
- Output current adjustable via the DIP switch (50mA a step)
- Flicker free
- Dimming range: 0%-100%; dimming depth: 0.1%
- Suitable for Class I & II light fixtures



Parameter

Model	Output Power (Max)	Output Voltage (V)	Output Current (mA)	Efficiency (full load)	PF	Warranty Tc
LF-GSD015YE	15W	25-42	100-350	85%(230Vac)	0.90(230Vac)	≤68°C
LF-GSD020YE	20W	25-42	200-500	87%(230Vac)	0.90(230Vac)	≤73°C
LF-GSD030YE	30W	25-42	550-750	87%(230Vac)	0.90(230Vac)	≤68°C
LF-GSD040YE	40W	25-42	800-1050	88%(230Vac)	0.90(230Vac)	≤68°C
LF-GSD060YE	60W	25-42	1100-1500	88%(230Vac)	0.90(230Vac)	≤77°C
LF-GSD080YE	80W	25-42	1550-2000	89%(230Vac)	0.90(230Vac)	≤77°C

Specification

Item	Parameter
• Operating Voltage	220-240Vac; 310-340Vdc
• Operating Voltage Limit	198-264Vac; 280-374Vdc
• THD	≤15%
• Ta	-30°C~+50°C
• Tc	90°C
• IP Rating	IP20
• Protection Characteristics	Open circuit, short circuit
• Withstanding Voltage	I/P-O/P: 3.75kV 5mA 60S

Dimensions

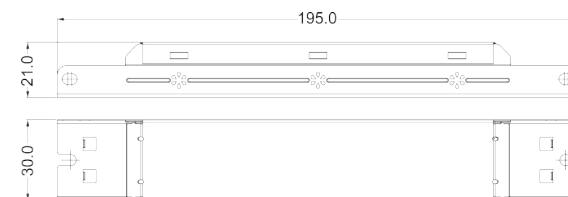

LF-GSD015YE

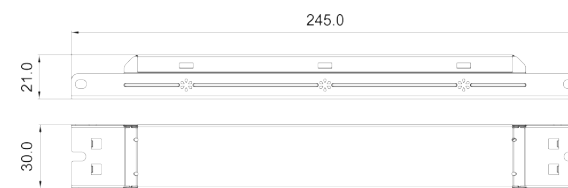

LF-GSD020/30/40YE

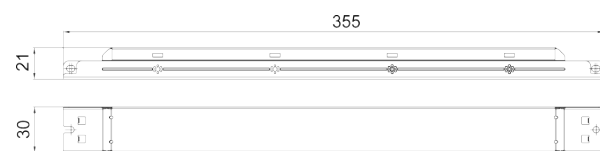

LF-GSD080YE

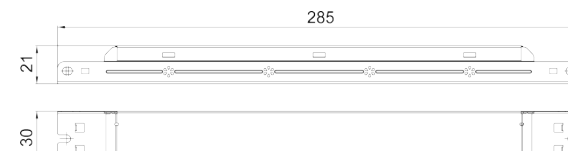

LF-GSD060YE

DALI-2 100-277Vac Dimming Series

LF-GSD045YB*34-44W



Feature

- DALI & Push dimming function in one
- Smooth dimming, optional logarithmic or linear dimming curve
- Output current adjustable via the DIP switch (50mA a step)
- Up to 10 drivers can be dimmed synchronously and share 1 IP address
- Flicker free
- Dimming range: 0%-100%; dimming depth: 5%
- Suitable for Class I & II light fixtures



Parameter

Model	Output Power (Max)	Output Voltage (V)	Output Current (mA)	Efficiency (full load)	PF	Warranty Tc
LF-GSD045YB	44W	25-42	800-1050	87%(230Vac)	0.95(230Vac)	≤73°C

Specification

Item	Parameter
• Operating Voltage	100-277Vac
• THD	≤20%
• Ta	-30°C~+50°C
• Tc	90°C
• IP Rating	IP20
• Protection Characteristics	Open circuit, short circuit
• Withstanding Voltage	I/P-O/P: 3.75kV 5mA 60S, I/P-PGND: 1.6kV 5mA 60S

Dimensions

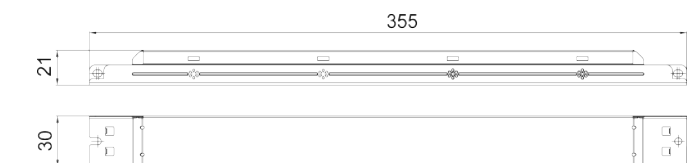

LF-GSD045YB

DALI Converter

LF-SCD010A/B/C



Feature

- DALI2.0 certified (LF-SCD010A)
- Optional power supply: AC, DC or no power supply
- IP67 (LF-SCD010B/C)
- Use cables with the diameter of 5mm to 8mm (LF-SCD010B/C)
- Optional logarithmic or linear dimming curve



Parameter

Model	Input Dimming Signal	Input Current	Input Voltage	Output Dimming Mode	Output Source Current	Light Fixture Qty
LF-SCD010A	DALI/PUSH	100mA	100-240Vac	0-10V	25mA	1-20
LF-SCD010B	DALI/PUSH	≤50mA	11-13Vdc	0-10V	25mA	1-10
LF-SCD010C	DALI	≤5mA	DALI bus power supply	PWM	5mA	1

Specification

Item	Parameter
• Warranty (Tc)	≤ 75°C
• Ta	-30°C~+55°C / -30°C~+60°C
• IP Rating	IP67 / IP20
• Protection Characteristics	Open circuit, short circuit
• Withstanding Voltage	I/P-DALI: 1.5kVac <5mA 60S

Dimensions

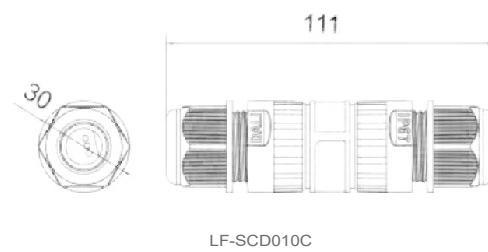
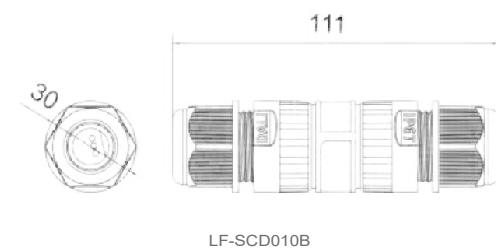
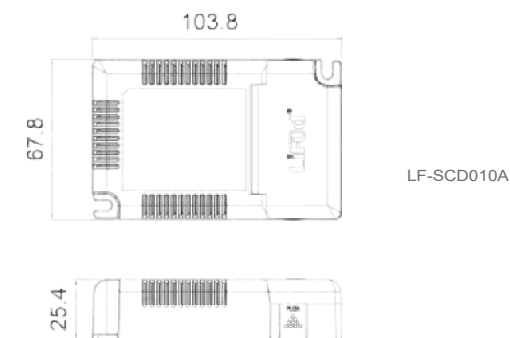

DALI Bus Power Supply

LF-GSD005YD*power supply for all devices connected to the DALI BUS

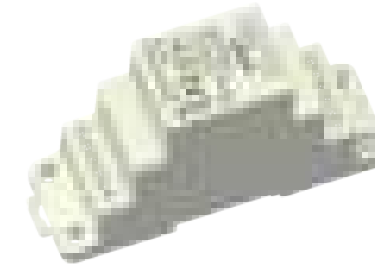

Feature

- Two installation methods: din-rail mounting or screw fixation
- Equipped with DALI signal indicator
 - Green: Normal operation
 - Flash: There is a dimming instruction in the DALI system
 - Off: Abnormal dimming signal
- Three sets of terminal blocks at both of the input and the output
- Compatible with wires of 0.5-2.5mm



Parameter

Model	Output Voltage (V)	Output Current (mA)	Warranty Tc	Ripple (voltage)
LF-GSD005YD	16±5%	230±10mA	≤ 80°C	<0.5V@50HZ&220Vac

Specification

Item	Parameter
• Operating Voltage	100-240Vac; 120-288Vdc
• Operating Voltage Limit	90-264Vac; 108-316Vdc
• Ta	-20°C~+50°C
• IP Rating	IP20
• Protection Characteristics	Open circuit, short circuit, over current, over voltage
• Withstanding Voltage	I/P-O/P: 3.75kV 5mA 60S

Dimensions

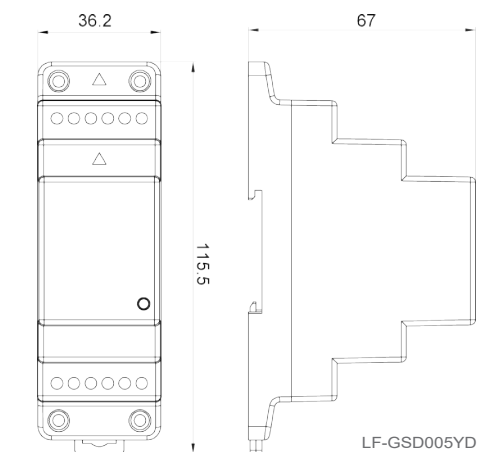

Constant Current DALI-2 Dimming IP67 Series

LF-GSDxxxYH*4-50W



Feature

- High efficiency up to 88%, THD≤10%
- Flicker free during the whole dimming process
- Output current adjustable via the potentiometer
- Surge Protection: L-N: 4KV; L/N-GND: 6KV
- Dimming range: 0%-100%; dimming depth: 3%



Parameter

Model	Output Power (Max)	Output Voltage (V)	Output Current (mA)	Efficiency (full load)	PF
LF-GSD010YH	10W	25-42	100-300	82%(230Vac)	0.90(230Vac)
LF-GSD015YH	15W	25-42	250-450	83%(230Vac)	0.95(230Vac)
LF-GSD022YH	22W	25-42	350-550	85%(230Vac)	0.95(230Vac)
LF-GSD030YH	30W	25-42	550-750	86%(230Vac)	0.95(230Vac)
LF-GSD040YH	40W	25-42	800-1050	87%(230Vac)	0.95(230Vac)
LF-GSD050YH	50W	25-42	1100-1300	88%(230Vac)	0.95(230Vac)

Specification

Item	Parameter
• Operating Voltage	220-240Vac
• Operating Voltage Limit	198-264Vac
• THD	≤10%
• Ta	-20°C ~ +50°C
• Tc	90°C
• IP Rating	IP67
• Protection Characteristics	Open circuit, short circuit, over temperature, surge protection
• Withstanding Voltage	I/P-O/P: 3.75KVac <5mA 60S

Dimensions

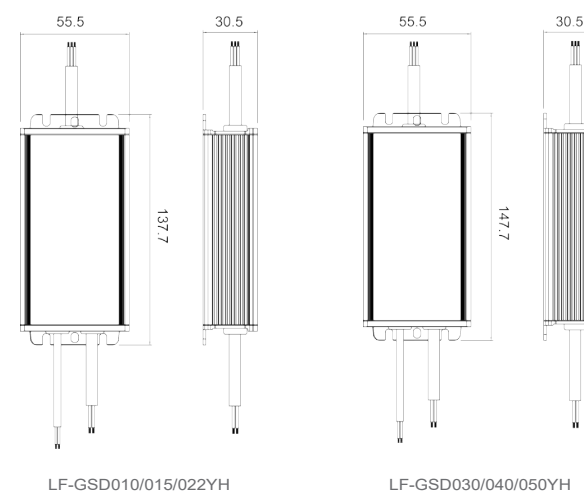

Constant Voltage DALI-2 Dimming IP67 Series

LF-KADxxx12/24*100-240W

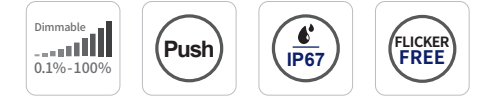

Feature

- High efficiency up to 88%, THD≤10%
- Flicker free during the whole dimming process
- Output voltage adjustable via the potentiometer
- Surge Protection: L-N: 4KV; L/N-GND: 6KV
- Dimming range: 0%-100%; dimming depth: 0.1%



Parameter

Model	Output Power (Max)	Output Voltage (V)	Output Current (A)	Efficiency (full load)	PF
LF-KAD100-12	100W	12	0-8.3	92%(230Vac)	0.95(230Vac)
LF-KAD100-24	100W	24	0-4.2	92%(230Vac)	0.95(230Vac)
LF-KAD120-12	120W	12	0-10	92%(230Vac)	0.95(230Vac)
LF-KAD150-24	150W	24	0-6.25	92%(230Vac)	0.95(230Vac)
LF-KAD240-12	240W	12	0-20	93%(230Vac)	0.95(230Vac)
LF-KAD240-24	240W	24	0-10	93%(230Vac)	0.95(230Vac)

*LF-KADxxx-12/24 will be released in Q4 of 2021.

Specification

Item	Parameter
• Operating Voltage	220-240Vac
• Operating Voltage Limit	198-264Vac
• THD	≤10%
• Ta	-20°C ~ +50°C
• Tc	90°C
• IP Rating	IP67
• Protection Characteristics	Open circuit, short circuit, over temperature, surge protection
• Withstanding Voltage	I/P-O/P: 3.75KVac <5mA 60S

Dimensions

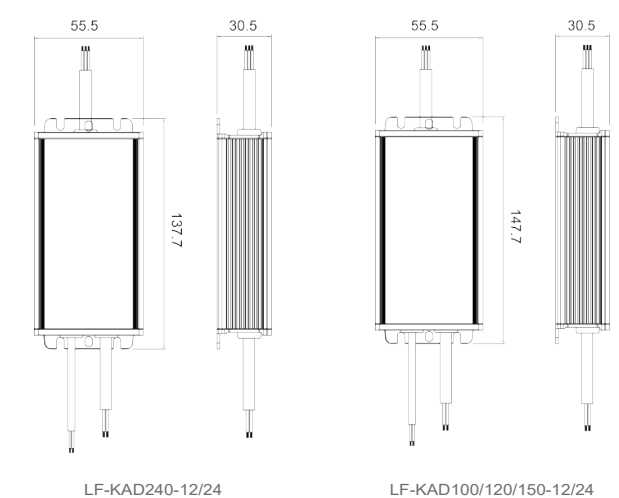

Constant Voltage DALI-2 DT8 Tunable White Series

LF-GSDxxxYVxxA* 75-150W



Feature

- High efficiency up to 93%
- Flicker free during the whole dimming process
- Dimming range: 0%-100%; dimming depth: 0.1%
- Adjustable CCT



Parameter

Model	Output Power (Max)	Output Voltage (V)	Output Current (A)	Efficiency (full load)	PF
LF-GSD075YV024A	75W	24	0-3.125	91%(230Vac)	0.95(230Vac)
LF-GSD120YV012A	120W	12	0-10	93%(230Vac)	0.95(230Vac)
LF-GSD150YV024A	150W	24	0-6.25	93%(230Vac)	0.95(230Vac)

Specification

Item	Parameter
• Operating Voltage	220-240Vac; 310-340Vdc
• Operating Voltage Limit	198-264Vac; 280-374Vdc
• THD	≤15%
• Ta	-30°C ~ +50°C
• Tc	90°C
• IP Rating	IP20
• Protection Characteristics	Open circuit, short circuit
• Withstanding Voltage	I/P-O/P: 3.75kV 5mA 60S

Dimensions

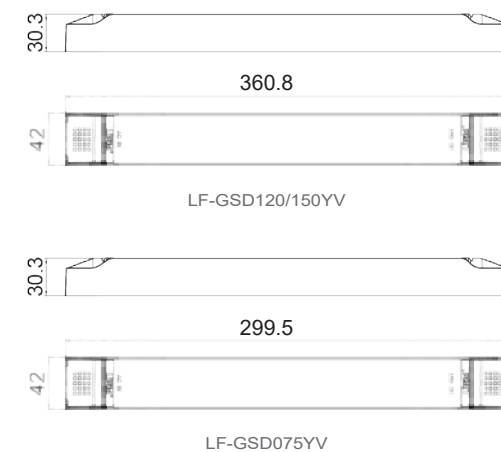

Constant Voltage DALI-2 DT6 Dimming Series

LF-GSDxxxYVxxB*75-150W



Feature

- High efficiency up to 93%
- Flicker free during the whole dimming process
- Dimming range: 0%-100%; dimming depth: 0.1%



Parameter

Model	Output Power (Max)	Output Voltage (V)	Output Current (A)	Efficiency (full load)	PF
LF-GSD075YV024B	75W	24	0-3.125	88%(230Vac)	0.95(230Vac)
LF-GSD120YV012B	120W	12	0-10	93%(230Vac)	0.95(230Vac)
LF-GSD150YV024B	150W	24	0-6.25	93%(230Vac)	0.95(230Vac)

Specification

Item	Parameter
• Operating Voltage	220-240Va; 310-340Vdc
• Operating Voltage Limit	198-264Vac; 280-374Vdc
• THD	≤15%
• Ta	-30°C ~ +50°C
• Tc	90°C
• IP Rating	IP20
• Protection Characteristics	Open circuit, short circuit
• Withstanding Voltage	I/P-O/P: 3.75kV 5mA 60S

Dimensions

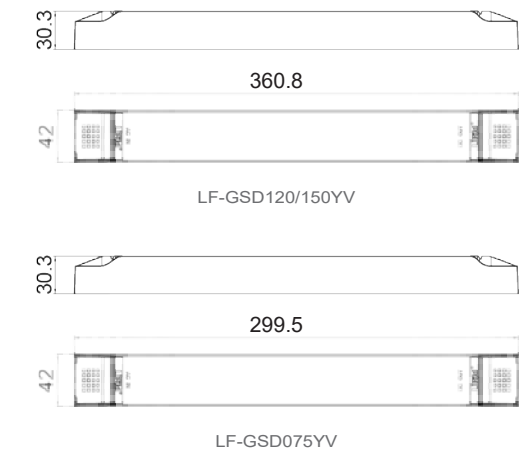

Triac Dimming Wiring Diagram

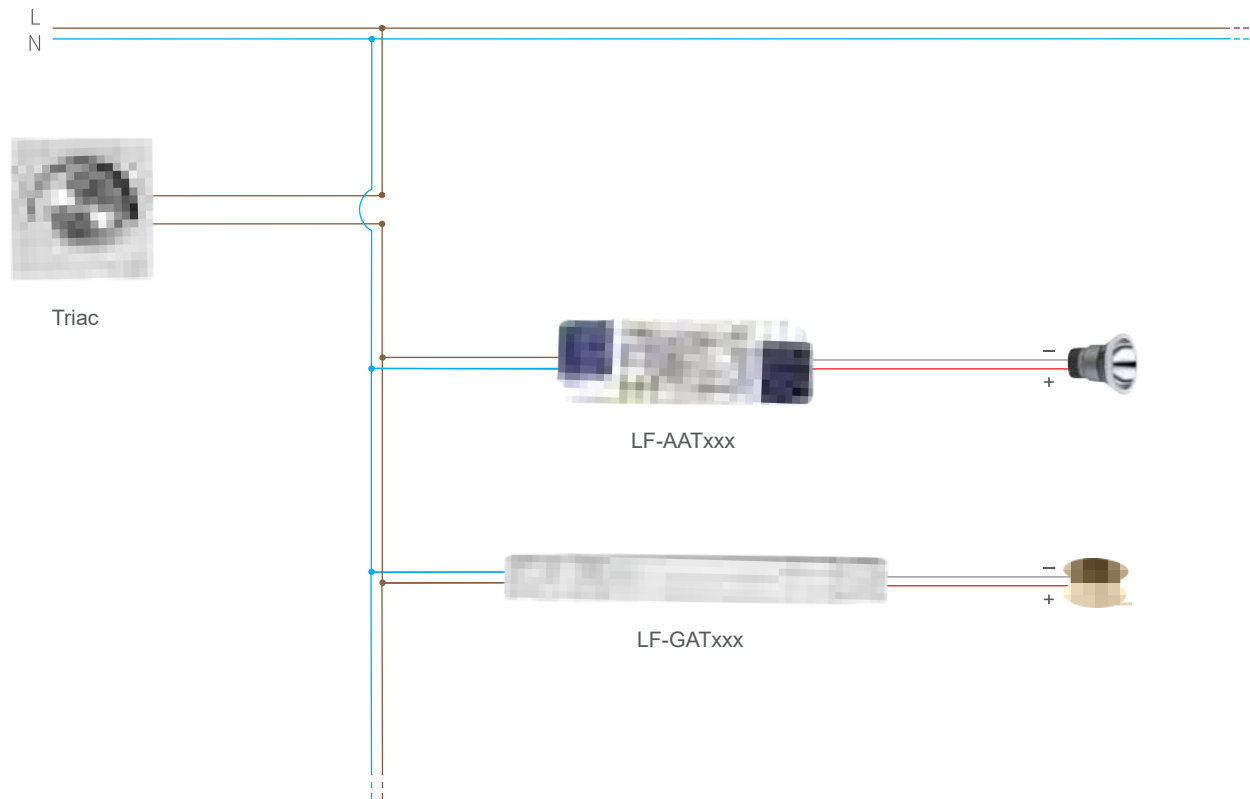

General Problem in Application:

Some inferior dimmable LED drivers can not work stably because they will flicker when the light is "still very bright" for human eyes.

Conventional Solution:

Dim the light off when it is "still very bright". But if the dimming depth only reaches 30%, dimming function means nothing.

Lifud Triac Timmable LED Driver:

By actual test, the illuminance ranges from 100lx to 10020lx. And the dimming depth can reach 0.1% without flicker.

220-240Vac Triac Dimming Series

LF-GDExxxYG*1-30W



Feature

- Compatible with 35 mainstream brands of dimmer
- Output current adjustable via the DIP switch (except for LF-GDE003YG)
- Flicker free (except for LF-GDE003YG)
- Suitable for Class II light fixtures



Parameter

Model	Output Power (Max)	Output Voltage (V)	Output Current (mA)	PF	Warranty Tc
LF-GDE003YG	3W	3-11	150-350	0.90(230Vac)	≤75°C
LF-GDE008YG(L)	8W	12-22	300-350	0.90(230Vac)	≤87.4°C
LF-GDE008YG(H)	8W	25-40	135-200	0.90(230Vac)	≤87°C
LF-GDE014YG	14W	25-40	250-350	0.90(230Vac)	≤77°C
LF-GDE020YG	20W	25-40	400-550	0.90(230Vac)	≤82°C
LF-GDE030YG	30W	25-40	600-700	0.90(230Vac)	≤87°C

Specification

Item	Parameter
• Operating Voltage	220-240Vac
• Operating Voltage Limit	198-264Vac
• THD	≤20%
• Ta	-30°C~+50°C
• Tc	90°C
• IP Rating	IP20
• Protection Characteristics	Open circuit, short circuit
• Withstanding Voltage	I/P-O/P: 3.75kV 5mA 60S

Dimensions

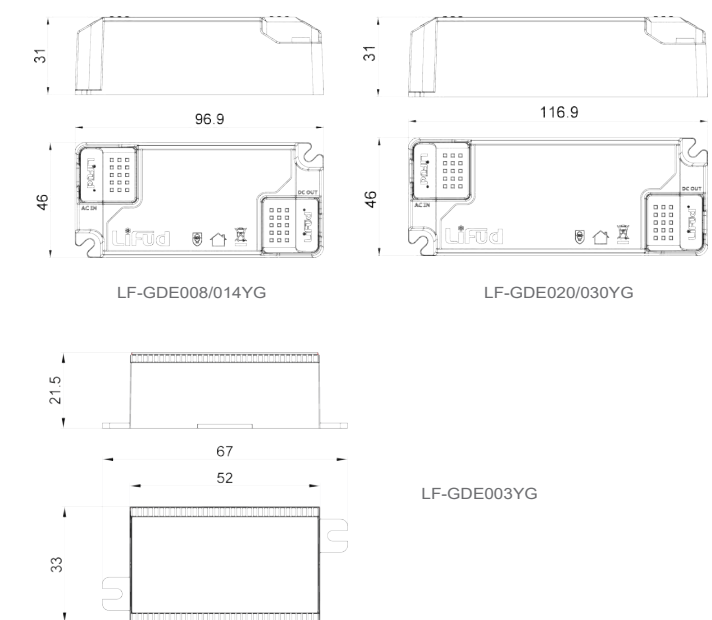

100-120Vac Triac Dimming Series

LF-GDExxxYD* 8-30W

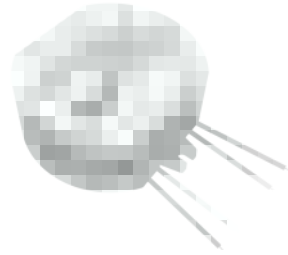

Feature

- High PF, low THD
- Excellent compatibility



Parameter

Model	Output Power (Max)	Output Voltage (V)	Output Current (mA)	Efficiency (full load)	PF	Warranty Tc
LF-GDE012YD	12W	25-40	200-300	83%(230Vac)	0.90(230Vac)	≤75°C
LF-GDE024YD	24W	25-40	350-600	83%(230Vac)	0.90(230Vac)	≤75°C
LF-GDE030YD	30W	25-40	650-750	83%(230Vac)	0.90(230Vac)	≤75°C

Specification

Item	Parameter
• Operating Voltage	100-120Vac
• Operating Voltage Limit	100-140Vac
• THD	≤20%
• Ta	-30°C~+50°C
• Tc	90°C
• IP Rating	IP20
• Protection Characteristics	Open circuit, short circuit
• Withstanding Voltage	I/P-O/P:3.75kVac,<5mA 60S

Dimensions

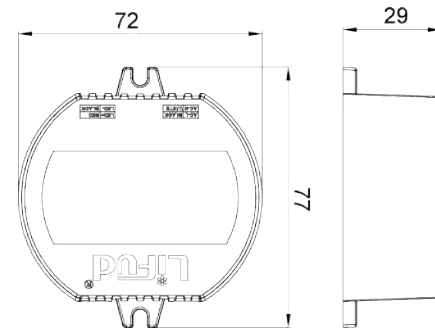

LF-GDE012/024/030YD

Constant Current Triac Dimming Series

LF-AATxxx*8-40W

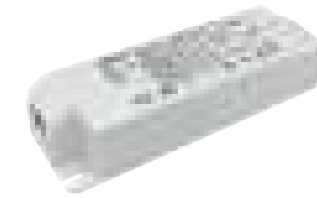

Feature

- Output current adjustable via the DIP switch (50mA a step)
- Smooth dimming, flicker free during the whole dimming process
- Support leading edge dimming and trailing edge dimming
- Dimming range: 0%-100%; dimming depth: 0.1%
- Suitable for Class II light fixtures



Parameter

Model	Output Power (Max)	Output Voltage (V)	Output Current (mA)	Efficiency (full load)	PF	Warranty Tc
LF-AAT008-0700-12	8W	2-12	350-700	76%(230Vac)	0.90(230Vac)	≤ 86°C
LF-AAT008-0350-42	8W	9-42	100-350	76%(230Vac)	0.90(230Vac)	≤ 86°C
LF-AAT010-0300-42	10W	9-42	100-300	83%(230Vac)	0.90(230Vac)	≤ 86°C
LF-AAT012-0400-42	12W	9-42	150-400	83%(230Vac)	0.90(230Vac)	≤ 86°C
LF-AAT015-0450-42	15W	9-42	200-450	83%(230Vac)	0.90(230Vac)	≤ 86°C
LF-AAT020-0400-42	20W	9-42	250-500	85%(230Vac)	0.90(230Vac)	≤ 86°C
LF-AAT030-0750-42	30W	9-42	400-750	86%(230Vac)	0.95(230Vac)	≤ 80°C
LF-AAT040-1050-42	40W	9-42	800-1050	87%(230Vac)	0.95(230Vac)	≤ 80°C

*LF-AATxxx will be released in Q3 of 2021.

Specification

Item	Parameter
• Operating Voltage	220-240Vac; 310-340Vdc
• Operating Voltage Limit	198-264Vac; 280-374Vdc
• THD	≤15%
• Ta	-30°C ~ +50°C
• Tc	90°C
• IP Rating	IP20
• Protection Characteristics	Open circuit, short circuit
• Withstanding Voltage	I/P-O/P: 3.75kV 5mA 60S

Dimensions

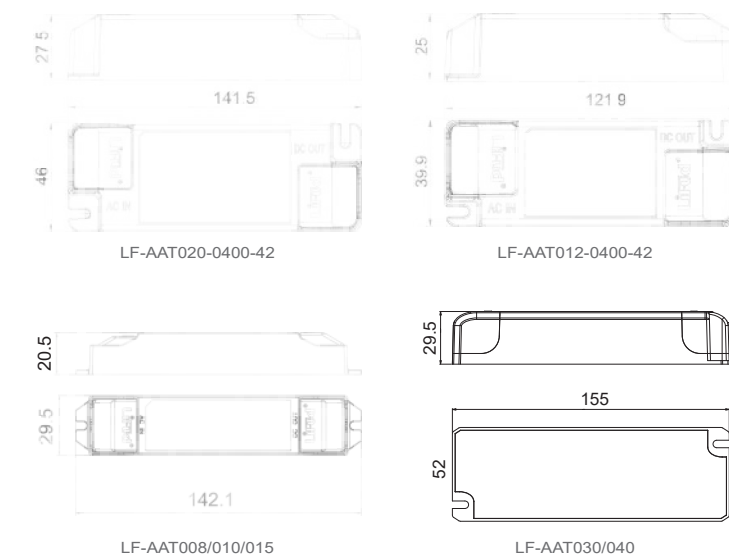

Constant Voltage Triac Dimming Series

LF-GATxxx*75-150W

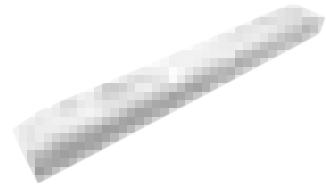
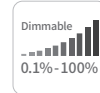

Feature

- Smooth dimming, flicker free during the whole dimming process
- Support leading edge dimming and trailing edge dimming
- Dimming range: 0%-100%; dimming depth: 0.1%
- Suitable for Class II light fixtures



Parameter

Model	Output Power (Max)	Output Voltage (V)	Output Current (A)	Efficiency (full load)	PF
LF-GAT075-3125-24	75W	24	0-3.125	92%(230Vac)	0.95(230Vac)
LF-GAT150-6250-24	150W	24	0-6.25	93%(230Vac)	0.95(230Vac)

Specification

Item	Parameter
• Operating Voltage	220-240Vac; 310-340Vdc
• Operating Voltage Limit	198-264Vac; 280-374Vdc
• THD	≤15%
• Ta	-30°C ~ +50°C
• Tc	90°C
• IP Rating	IP20
• Protection Characteristics	Open circuit, short circuit
• Withstanding Voltage	I/P-O/P: 3.75kV 5mA 60S

Dimensions



Constant Voltage 0-10V Dimming Series

LF-GDExxxYV* 75-150W

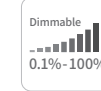

Feature

- 3-in-1 dimming function: 0-10V/PWM/Rx
- Flicker free during the whole dimming process
- Dimming range: 0%-100%; dimming depth: 0.1%



Parameter

Model	Output Power (Max)	Output Voltage (V)	Output Current (A)	Efficiency (full load)	PF
LF-GDE075YV	75W	24	0-3.125	88%(230Vac)	0.95(230Vac)
LF-GDE120YV	120W	12	0-10	93%(230Vac)	0.95(230Vac)
LF-GDE150YV	150W	24	0-6.25	93%(230Vac)	0.95(230Vac)

Specification

Item	Parameter
• Operating Voltage	220-240Vac; 310-340Vdc
• Operating Voltage Limit	198-264Vac; 280-374Vdc
• THD	≤15%
• Ta	-30°C ~ +45°C
• Tc	90°C
• IP Rating	IP20
• Protection Characteristics	Open circuit, short circuit
• Withstanding Voltage	I/P-O/P: 3.75kV 5mA 60S

Dimensions

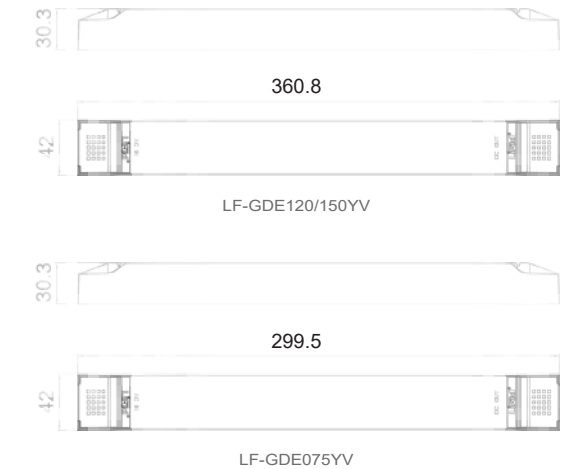

Constant Current 0-10V Dimming Series

LF-AAAxxx*8-40W



Feature

- Output current adjustable via the DIP switch (50mA a step)
- 3-in-1 dimming function: 0-10V/PWM/Rx
- Smooth dimming effect: flicker free in the whole dimming process
- Dimming range: 0%-100%; dimming depth: 0.1%
- 12V 50mA auxiliary power supply (except for LF-AAA008)



Parameter

Model	Output Power (Max)	Output Voltage (V)	Output Current (mA)	Efficiency (full load)	PF	Warranty Tc
LF-AAA008-0700-12	8W	2-12	350-700	76%(230Vac)	0.90(230Vac)	≤86°C
LF-AAA008-0350-42	8W	9-42	100-350	76%(230Vac)	0.90(230Vac)	≤86°C
LF-AAA010-0300-42	10W	9-42	100-300	85%(230Vac)	0.95(230Vac)	≤86°C
LF-AAA012B-0400-42	12W	9-42	150-400	83%(230Vac)	0.90(230Vac)	≤86°C
LF-AAA015-0450-42	15W	9-42	200-450	85%(230Vac)	0.95(230Vac)	≤86°C
LF-AAA020B-0500-42	20W	9-42	300-500	85%(230Vac)	0.95(230Vac)	≤86°C
LF-AAA030B-0700-42	30W	9-42	550-700	86%(230Vac)	0.95(230Vac)	≤80°C
LF-AAA040B-1050-42	40W	9-42	750-1050	87%(230Vac)	0.95(230Vac)	≤78°C

*LF-AAA010-0300-42 and LF-AAA015-0450-42 will be released in Q3 of 2021.

Specification

Item	Parameter
• Operating Voltage	220-240Vac; 310-340Vdc
• Operating Voltage Limit	198-264Vac; 280-374Vdc
• THD	≤15%
• Ta	-30°C ~ +45°C
• Tc	90°C
• IP Rating	IP20
• Protection Characteristics	Open circuit, short circuit
• Withstanding Voltage	I/P-O/P: 3.75kV 5mA 60S

Dimensions

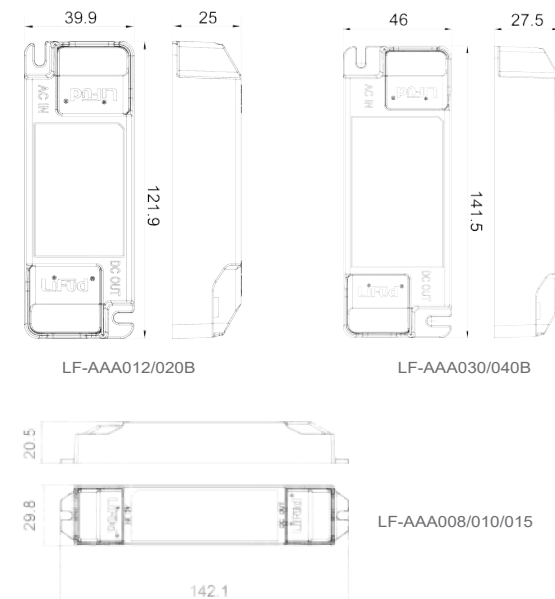

Linear Emergency Series

LF-GSPxxxYD* 14-40W



Feature

- Consist of an LED driver and an emergency control unit
- Battery separated, standard emergency time ≥90mins
- Pass CE certification with Ni-MH battery (LF-GSP040YD)
- Flicker free



Parameter

Model	Output Power (Max)	Output Voltage (V)	Output Current (mA)	Efficiency (full load)	PF	Warranty Tc
LF-GSP020YD	20W	30-40	350-500	77%(230Vac)	0.93(230Vac)	≤85°C
LF-GSP040YD	40W	30-40	700-1000	80%(230Vac)	0.93(230Vac)	≤85°C

Specification

Item	Parameter
• Operating Voltage	100-277Vac
• Operating Voltage Limit	90-305Vac
• Emergency Current	350mA
• THD	≤20%
• Ta	-30°C~+40°C (40W) -20°C~+40°C (20W)
• Tc	90°C
• Protection Characteristics	Driver: open circuit, short circuit Battery: over charging, over discharging, reversed connection

Dimensions

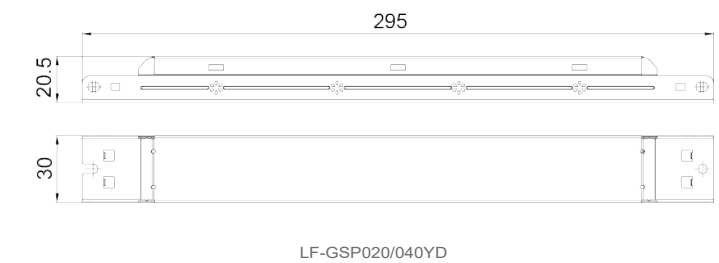

Constant Power Emergency Series (Independent Battery)

LF-GSP012YH* 5/7/10/12W



Feature

- Output power adjustable (5/7/10/12W) via the DIP switch
- Constant output power, matching different LED loads
- Independent battery pack, driver inside the light fixture
- Flicker free



Parameter

Model	Output Power (Max)	Output Voltage (V)	Output Current (mA)	Battery Specification
LF-GSP012YH	12W	25-48	≤500	With a 2000mAH Ni-Cd battery

Specification

Item	Parameter
• Operating Voltage	100-277Vac
• Emergency Current	≤500mA
• Ta	0~50°C
• Tc	59.3°C
• Protection Characteristics	Driver: open circuit, short circuit, under voltage Battery: over charging, over discharging, reversed connection
• Constant Power Emergency Range	DC25-48V currents≤2A

Dimensions



LF-GSP012YH

Emergency Time

Emergency Power	Duration
5W	≥3h
7W	≥2h
10W	≥90mins
12W	≥90mins

Constant Power Emergency Series (Internal Battery)

LF-GSPxxxYG* 5/7/10/12W

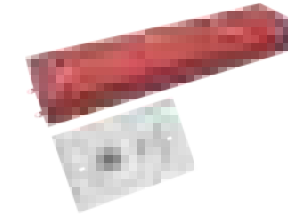

Feature

- Output power adjustable (5/7/10/12W) via the DIP switch
- Constant output power, matching different LED loads
- Internal battery pack, driver can be externally used



Parameter

Model	Output Power (Max)	Output Voltage (V)	Output Current (mA)	Battery Specification
LF-GSP007YG	7W	25-48	≤300	With a 1200mAH Ni-Cd battery
LF-GSP012YG	12W	25-48	≤500	With a 2000mAH Ni-Cd battery

Specification

Item	Parameter
• Operating Voltage	100-277Vac
• Emergency Current	≤300mA
• Ta	0~50°C
• Tc	59.9°C
• Protection Characteristics	Driver: open circuit, short circuit, under voltage Battery: over charging, over discharging, reversed connection
• Constant Power Emergency Range	DC25-48V currents≤2A

Dimensions

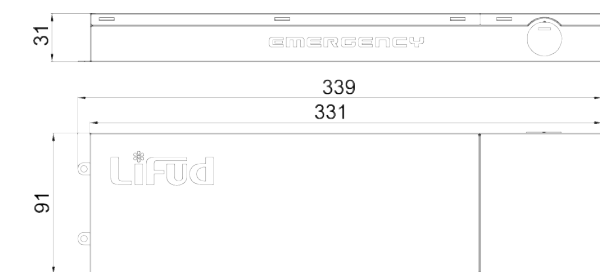

LF-GSP007/012YG

Emergency Time

Emergency Power	Duration
5W	≥3h
7W	≥2h
10W	≥90mins
12W	≥90mins



Commercial Lighting LED Driver



Lifud, not only a
leader in panel light
LED driver

220-240Vac Mini Size Series

LF-GIRxxxYS/YS(B)*1-7W



Feature

- Mini size: around 2.4cm thick
- High output current: 1.2/1.5/1.8A, can driver a high power LED of 3V2A
- High reliability: use double-sided PCB process
- Flicker free
- LF-GIRxxxYS: external assembly ; LF-GIRxxxYS(B): built-in assembly
- Suitable for Class II light fixtures



Parameter

Model	Output Power (Max)	Output Voltage (V)	Output Current (mA)	Efficiency (full load)	PF	Warranty Tc
LF-GIR003YS/YS(B)	3W	5-10	300	70%(230Vac)	0.40(230Vac)	≤74°C
LF-GIR003YS/YS(B)	3W	2-4	300/350/600/700	65%(230Vac)	0.43(230Vac)	≤74°C
LF-GIR007YS/YS(B)	7W	5-10	350/500/600/700	74%(230Vac)	0.45(230Vac)	≤78°C
LF-GIR007YS/YS(B)	7W	30-40	70/110/135/160/180	81%(230Vac)	0.45(230Vac)	≤77°C

Specification

Item	Parameter
• Operating Voltage	220-240Vac; 280-340Vdc
• Operating Voltage Limit	198-264Vac
• Tc	74°C
• Ta	-20°C~+50°C
• IP Rating	IP20
• Protection Characteristics	Open circuit, short circuit
• Withstanding Voltage	I/P-O/P: 3.75KVac <5mA 60S

Dimensions

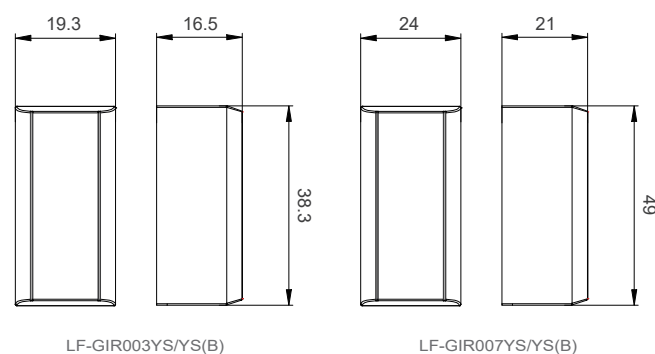

LF-GIR003YS/YS(B)

LF-GIR007YS/YS(B)

220-240Vac Low PF Series

LF-GIRxxxYS*5-24W



Feature

- Flicker free
- Screw-free design makes it easy for wiring
- Suitable for Class II light fixtures



Parameter

Model	Output Power (Max)	Output Voltage (V)	Output Current (mA)	Efficiency (full load)	PF	Warranty Tc
LF-GIR009YS	9W	25-42	135-200	82%(230Vac)	0.50(230Vac)	≤65°C
LF-GIR009YS	9W	14-24	300-350	82%(230Vac)	0.50(230Vac)	≤65°C
LF-GIR009YS	9W	8-13	300-700	82%(230Vac)	0.50(230Vac)	≤65°C
LF-GIR013YS	13W	25-42	220-300	86%(230Vac)	0.50(230Vac)	≤80°C
LF-GIR013YS	13W	25-38	320-350	86%(230Vac)	0.50(230Vac)	≤80°C
LF-GIR013YS	13W	14-24	500-550	86%(230Vac)	0.50(230Vac)	≤65°C
LF-GIR013YS	13W	14-22	600	85%(230Vac)	0.50(230Vac)	≤65°C
LF-GIR024YS	24W	25-42	400-550	89%(230Vac)	0.50(230Vac)	≤80°C
LF-GIR024YS	24W	25-39	600	89%(230Vac)	0.50(230Vac)	≤80°C

Specification

Item	Parameter
• Operating Voltage	220-240Vac
• Operating Voltage Limit	180-264Vac
• Tc	80°C
• Ta	-30°C~+50°C
• IP Rating	IP20
• Protection Characteristics	Open circuit, short circuit
• Withstanding Voltage	I/P-O/P: 3.75KVac <5mA 60S

Dimensions

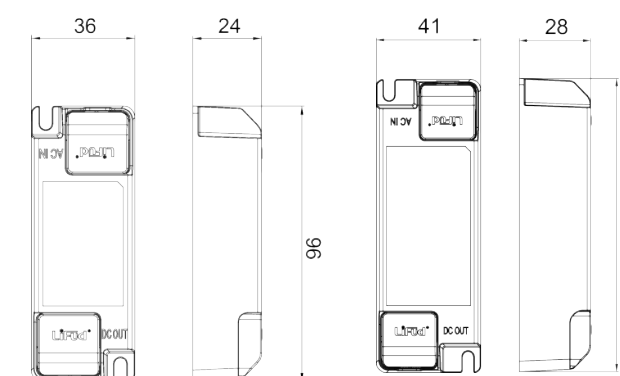

LF-GIR009/013YS

LF-GIR024YS

220-240Vac Conventional Series

LF--GIRxxxYM*8-60W

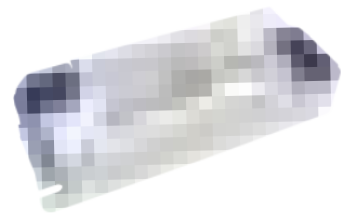

Feature

- High efficiency up to 89%
- Screw-free design makes it easy for wiring
- Suitable for Class II light fixtures



Parameter

Model	Output Power (Max)	Output Voltage (V)	Output Current (mA)	Efficiency (full load)	PF	Warranty Tc
LF-GIR015YM	15W	25-40	110-350	83%(230Vac)	0.90(230Vac)	≤78°C
LF-GIR022YM	22W	25-40	400-550	85%(230Vac)	0.90(230Vac)	≤78°C
LF-GIR030YM	30W	25-42	500-750	88%(230Vac)	0.90(230Vac)	≤85°C
LF-GIR040YM	40W	25-42	800-1050	88%(230Vac)	0.90(230Vac)	≤80°C
LF-GIR050YM	50W	25-42	1050-1300	89%(230Vac)	0.90(230Vac)	≤70°C
LF-GIR050YM	50W	40-55	800-900	89%(230Vac)	0.90(230Vac)	≤70°C
LF-GIR060YM	60W	25-42	1200-1500	89%(230Vac)	0.90(230Vac)	≤70°C
LF-GIR060YM	60W	40-55	900-1100	89%(230Vac)	0.90(230Vac)	≤70°C

Specification

Item	Parameter
• Operating Voltage	220-240Vac
• Operating Voltage Limit	180-264Vac
• THD	<20%
• Tc	90°C
• Ta	-30°C~+50°C
• IP Rating	IP20
• Protection Characteristics	Open circuit, short circuit
• Withstanding Voltage	I/P-O/P: 3.75KVac <5mA 60S

Dimensions

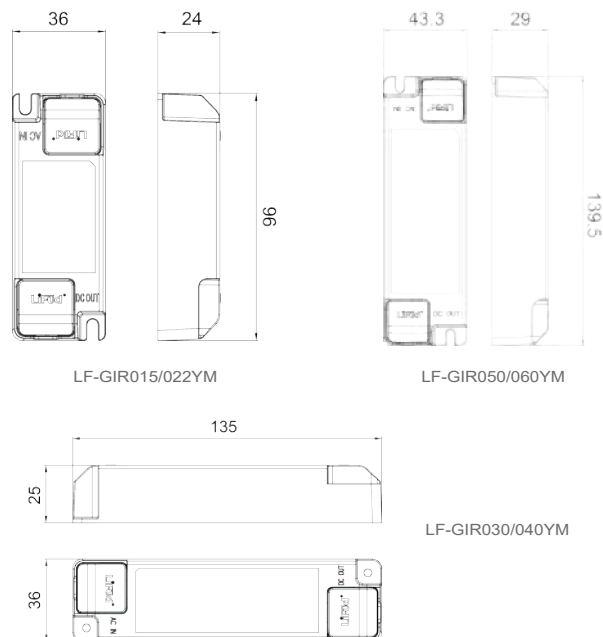

220-240Vac Built-in Series

LF-GIFxxxYF*15-40W

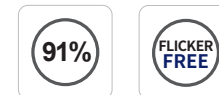

Feature

- Mini size, suitable for installation inside the light
- Flicker free
- High efficiency up to 91%
- Output current adjustable via the DIP switch (optional)
- Suitable for Class II light fixtures



Parameter

Model	Output Power (Max)	Output Voltage (V)	Output Current (mA)	Efficiency (full load)	PF	Warranty Tc
LF-GIF022YF	22W	30-42	350-500	87%(230Vac)	0.90(230Vac)	≤87°C
LF-GIF028YF	28W	30-42	550-700	91%(230Vac)	0.94(230Vac)	≤77°C
LF-GIF036YF	36W	30-42	750-900	91%(230Vac)	0.94(230Vac)	≤85°C
LF-GIF040YF	40W	30-42	950-1000	91%(230Vac)	0.94(230Vac)	≤85°C

Specification

Item	Parameter
• Operating Voltage	220-240Vac
• Operating Voltage Limit	200-264Vac
• THD	≤20%
• Ta	-30°C~+55°C
• Tc	90°C
• IP Rating	IP20
• Protection Characteristics	Open circuit, short circuit
• Withstanding Voltage	I/P-O/P: 3.75KVac <5mA 60S

Dimensions

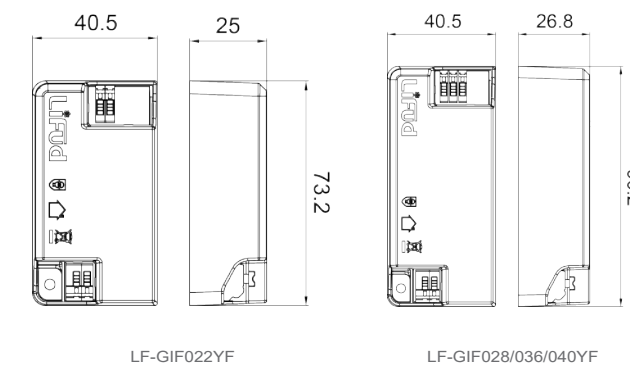

220-240Vac Round Casing Series

LF-GICxxxYS*16-20W



Feature

- Semi-glued; high-temperature resistant, Max. Ta: 60°C
- Flicker free
- High efficiency up to 86%
- Small size, suitable for installation
- Teflon wires, more durable
- Suitable for Class I & Class II light fixtures



Parameter

Model	Output Power (Max)	Output Voltage (V)	Output Current (mA)	Efficiency (full load)	PF	Warranty Tc
LF-GIC020YS	20W	27-40	400-550	86%(230Vac)	0.90(230Vac)	≤83°C

Specification

Item	Parameter
• Operating Voltage	220-240Vac
• Operating Voltage Limit	180-265Vac
• THD	≤20%
• Ta	-30°C ~ +60°C
• Tc	83°C
• IP Rating	IP40
• Protection Characteristics	Open circuit, short circuit
• Withstanding Voltage	I/P-O/P: 3.75KVac <5mA 60S

Dimensions

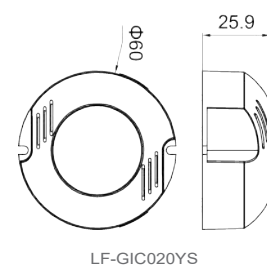

LF-GIC020YS

220-240Vac Round Casing Conventional Series

LF-GICxxxYB*12-42W



Feature

- High-temperature resistant, Max. Ta: 50°C
- High efficiency up to 89%
- Small size, suitable for built-in installation
- Teflon wires, more durable
- Suitable for Class II light fixtures



Parameter

Model	Output Power (Max)	Output Voltage (V)	Output Current (mA)	Efficiency (full load)	PF	Warranty Tc
LF-GIC020YB	20W	25-42	350-500	86%(230Vac)	0.90(230Vac)	≤90°C
LF-GIC030YB	30W	25-42	550-750	89%(230Vac)	0.90(230Vac)	≤90°C
LF-GIC040YB	40W	25-42	800-1000	88%(230Vac)	0.90(230Vac)	≤90°C

Specification

Item	Parameter
• Operating Voltage	220-240Vac
• Operating Voltage Limit	198-264Vac
• THD	≤20%
• Ta	-30°C ~ +55°C
• Tc	85°C
• IP Rating	IP20
• Protection Characteristics	Open circuit, short circuit
• Withstanding Voltage	I/P-O/P: 3.75KVac <5mA 60S

Dimensions

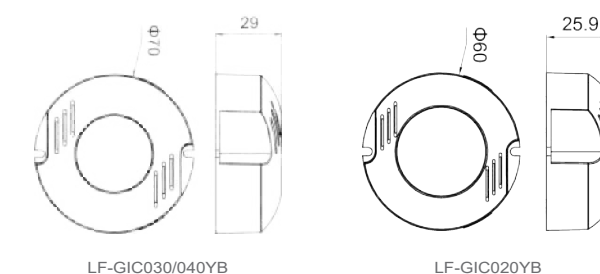

LF-GIC030/040YB

LF-GIC020YB

Classroom Lighting Hot-sale Series

LF-GIFxxxYAII*24-62W

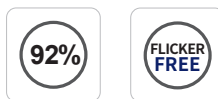

Feature

- Extraordinary flicker-free effect, luminous flux modulation depth near 0
- Use Lifud patented magnetic integration technology, high efficiency up to 92%
- Screw-free design makes it easy for wiring
- Suitable for Class II light fixtures



Parameter

Model	Output Power (Max)	Output Voltage (V)	Output Current (mA)	Efficiency (full load)	PF	Warranty Tc
LF-GIF030YAI	30W	33-40	600-800	91%(230Vac)	0.90(230Vac)	≤78°C
LF-GIF040YAI	40W	33-40	850-1000	92%(230Vac)	0.95(230Vac)	≤82°C
LF-GIF040YAI	40W	33-38	1050	92%(230Vac)	0.95(230Vac)	≤82°C
LF-GIF040YAI(H)	42W	35-42	900-1000	92%(230Vac)	0.95(230Vac)	≤82°C
LF-GIF040YAI(D)	42W	33-40	1050	92%(230Vac)	0.95(230Vac)	≤82°C
LF-GIF050YAI	52W	33-40	1100-1300	92%(230Vac)	0.95(230Vac)	≤84°C
LF-GIF060YAI	62W	33-40	1350-1550	92%(230Vac)	0.95(230Vac)	≤85°C

Specification

Item	Parameter
• Operating Voltage	220-240Vac
• Operating Voltage Limit	180-264Vac
• THD	≤20%
• Tc	90°C
• Ta	-30°C~+45°C
• IP Rating	IP20
• Protection Characteristics	Open circuit, short circuit
• Withstanding Voltage	I/P-O/P: 3.75KVac <5mA 60S

Dimensions

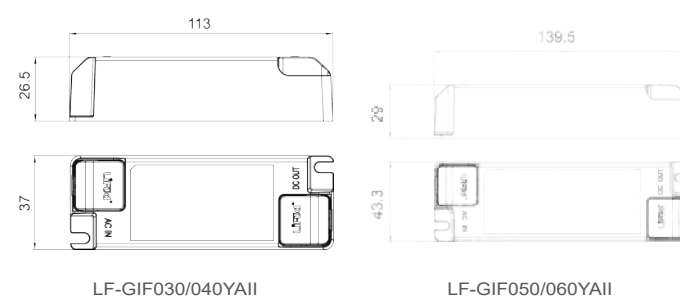

220-240Vac Plastic Casing Series

LF-GIFxxxYS*24-42W



Feature

- Flicker free, modulation depth<0.5%, IEC-PST≤1, CIE SVM≤0.4
- High efficiency up to 88%
- Low THD
- Suitable for Class II light fixtures



Parameter

Model	Output Power (Max)	Output Voltage (V)	Output Current (mA)	Efficiency (full load)	PF	Warranty Tc
LF-GIF030YS	30W	33-40	550-750	87%(220Vac)	0.90(220Vac)	≤84.2°C
LF-GIF040YS	42W	33-40	800-1050	88%(220Vac)	0.95(220Vac)	≤89°C

Specification

Item	Parameter
• Operating Voltage	220-240Vac
• Operating Voltage Limit	198-264Vac
• THD	<20%
• Ta	-30°C~+45°C
• Tc	90°C
• IP Rating	IP20
• Protection Characteristics	Short circuit, open circuit
• Withstanding Voltage	I/P-O/P: 3.75KVac

Dimensions

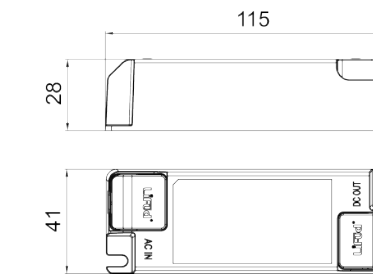

LF-GIF030/040YS

100-277Vac Plastic Casing Conventional Series

LF-GIRxxxYK*15-50W



Feature

- High efficiency up to 89%; low THD
- Active PFC design
- Suitable for Class II light fixtures



Parameter

Model	Output Power (Max)	Output Voltage (V)	Output Current (mA)	Efficiency (full load)	PF	Warranty Tc
LF-GIR020YK	20W	27-42	350/400/450/500	86%(230Vac)	0.92(230Vac)	≤70°C
LF-GIR030YK	30W	27-42	550/600/650/700/750	88%(230Vac)	0.95(230Vac)	≤75°C
LF-GIR040YK	40W	27-42	800/900/950/1000	89%(230Vac)	0.96(230Vac)	≤75°C
LF-GIR050YK	50W	27-42	1200/1300	88%(230Vac)	0.95(230Vac)	≤70°C

Specification

Item	Parameter
• Operating Voltage	100-277Vac
• Operating Voltage Limit	90-305Vac
• THD	≤18%
• Ta	-30°C~+50°C
• Tc	85°C
• IP Rating	IP20
• Protection Characteristics	Open circuit, short circuit
• Withstanding Voltage	I/P-O/P: 3.75KVac <5mA 60S

Dimensions

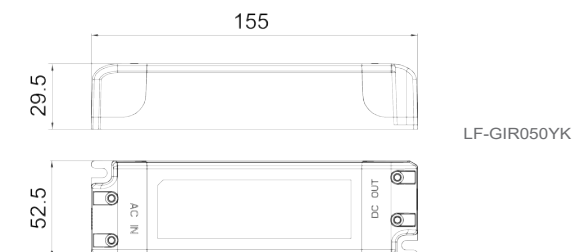
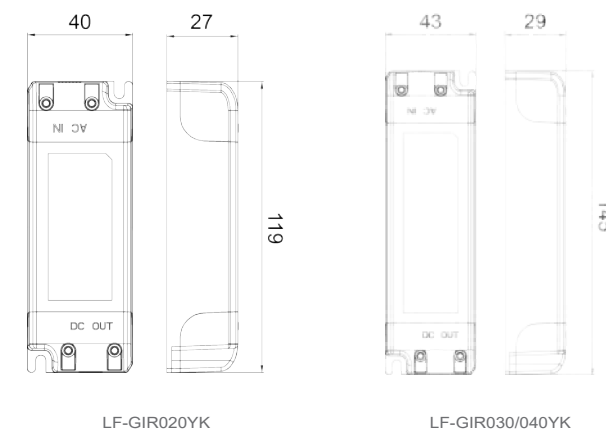

100-277Vac Plastic Casing Series

LF-GIFxxxYC*22-40W



Feature

- Flicker free (percent flicker≤0.5%)
- High efficiency up to 88%; low THD
- Suitable for Class I & II light fixtures



Parameter

Model	Output Power (Max)	Output Voltage (V)	Output Current (mA)	Efficiency (full load)	PF	Warranty Tc
LF-GIF030YC	30W	27-40	550-750	88%(230Vac)	0.95(230Vac)	≤75°C
LF-GIF040YC	40W	27-40	800-1050	88%(230Vac)	0.95(230Vac)	≤75°C

Specification

Item	Parameter
• Operating Voltage	100-277Vac
• Operating Voltage Limit	90-305Vac
• THD	≤18%
• Ta	-30°C ~ +50°C
• Tc	85°C
• IP Rating	IP20
• Protection Characteristics	Open circuit, short circuit
• Withstanding Voltage	I/P-O/P: 3.75KVac <5mA 60S

Dimensions

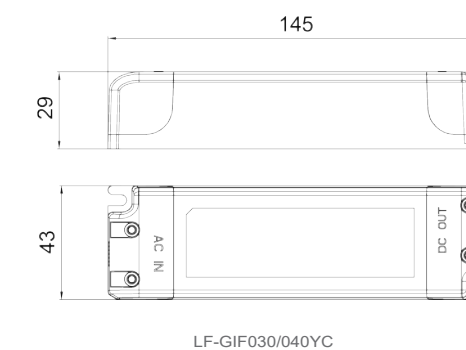

100-277Vac Panel Light Driver Series

LF-GMDxxxYS V *3-65W



Feature

- 3-in-1 dimming: 0-10V/PWM/Rx; can be dimmed to off
- Up to ten drivers/lights connected in parallel can be turned on/off synchronously
- Flicker free
- The output circuit is isolated from the dimming circuit
- Meet requirements of the DLC 5.0 certification
- The wiring port is specially designed for international need
- Suitable for Class I light fixtures

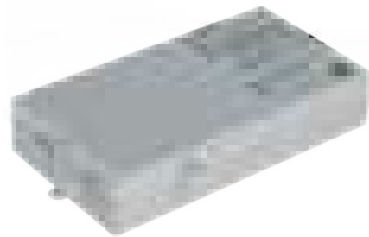

Parameter

Model	Output Power (Max)	Output Voltage (V)	Output Current (mA)	Efficiency (full load)	PF	Warranty Tc
LF-GMD035YS V	35W	25-42	100-800	85%(277Vac)	0.90(277Vac)	≤67°C
LF-GMD045YS V	45W	25-42	800-1100	86%(277Vac)	0.90(277Vac)	≤71°C
LF-GMD055YS V	55W	25-42	1100-1300	87%(278Vac)	0.90(277Vac)	≤71°C
LF-GMD065YS V	65W	25-42	1350-1650	87%(278Vac)	0.90(277Vac)	≤77°C

Specification

Item	Parameter
• Operating Voltage	100-277Vac
• THD	≤20%
• Ta	-30°C ~ +50°C
• Tc	90°C
• Protection Characteristics	Open circuit, short circuit, over voltage, under voltage, over current, over temperature
• Withstanding Voltage	I/P-O/P: 3.75KVac <5mA 60S

Dimensions

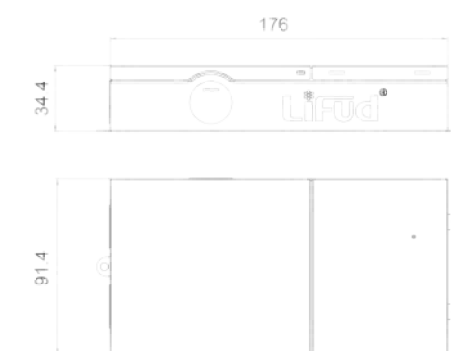

LF-GMD035/045/055/065YS V

100-277Vac Panel Light Driver Conventional Series

LF-GMDxxxYB V *8-65W



Feature

- 3-in-1 dimming: 0-10V/PWM/Rx; can be dimmed to off
- Up to ten drivers/lights connected in parallel can be turned on/off synchronously
- The output circuit is isolated from the dimming circuit
- Meet requirements of the DLC 5.0 certification
- The wiring port is specially designed for international need
- Suitable for Class I light fixtures

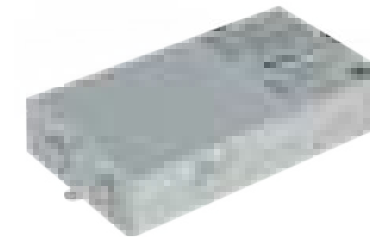

Parameter

Model	Output Power (Max)	Output Voltage (V)	Output Current (mA)	Efficiency (full load)	PF	Warranty Tc
LF-GMD035YB V	35W	25-42	300-800	88%(277Vac)	0.90(277Vac)	≤72°C
LF-GMD045YB V	45W	25-42	800-1100	88%(277Vac)	0.90(277Vac)	≤67°C
LF-GMD055YB V	55W	25-42	1100-1300	88%(277Vac)	0.90(277Vac)	≤71°C
LF-GMD065YB V	65W	25-42	1100-1650	88%(277Vac)	0.90(277Vac)	≤71°C

Specification

Item	Parameter
• Operating Voltage	100-277Vac
• THD	≤20%
• Ta	-30°C ~ +50°C
• Tc	90°C
• Protection Characteristics	Open circuit, short circuit, over voltage, under voltage, over current, over temperature
• Withstanding Voltage	I/P-O/P: 3.75KVac <5mA 60S

Dimensions

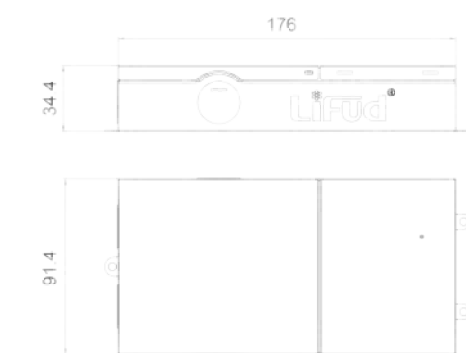

LF-GMD035/045/055/065YB V

100-277Vac Backlit Panel Light Driver Conventional Series

LF-GLDxxxYJ*35-55W

0-10V

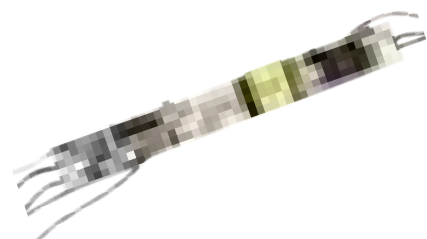

Feature

- 3-in-1 dimming: 0-10V/PWM/Rx; can be dimmed to off
- Up to ten drivers/lights connected in parallel can be turned on/off synchronously
- The output circuit is isolated from the dimming circuit
- Meet requirements of the DLC 5.1 certification
- Suitable for Class I light fixtures



Parameter

Model	Output Power (Max)	Output Voltage (V)	Output Current (mA)	Efficiency (full load)	PF	Warranty Tc
LF-GLD035YJ	35W	25-38	400-750	88%(120Vac)	0.95(120Vac)	≤50°C
LF-GLD035YJ	35W	36-48	350-750	88%(120Vac)	0.95(120Vac)	≤50°C
LF-GLD045YJ	45W	25-38	600-1100	89%(120Vac)	0.95(120Vac)	≤50°C
LF-GLD045YJ	45W	36-48	500-1100	89%(120Vac)	0.95(120Vac)	≤50°C
LF-GLD055YJ	55W	25-38	700-1300	87%(120Vac)	0.95(120Vac)	≤50°C
LF-GLD055YJ	55W	36-48	650-1050	87%(120Vac)	0.95(120Vac)	≤50°C

Specification

Item	Parameter
• Operating Voltage	100-277Vac
• THD	≤20%
• Ta	-30°C ~ +50°C
• Protection Characteristics	Open circuit, short circuit
• Withstanding Voltage	I/P-O/P: 3.75KVac <5mA 60S

Dimensions



LF-GLD035/045/055YJ

100-277Vac Backlit Panel Light Driver Series

LF-GLDxxxYI*35-55W

0-10V

FLICKER FREE

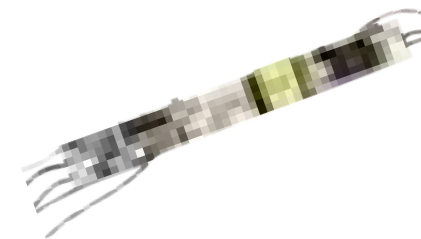

Feature

- 3-in-1 dimming: 0-10V/PWM/Rx; can be dimmed to off
- Up to ten drivers/lights connected in parallel can be turned on/off synchronously
- Flicker free
- The output circuit is isolated from the dimming circuit
- Meet requirements of the DLC 5.1 certification
- Suitable for Class I light fixtures



Parameter

Model	Output Power (Max)	Output Voltage (V)	Output Current (mA)	Efficiency (full load)	PF	Warranty Tc
LF-GLD035YI	35W	25-38	400-750	87%(120Vac)	0.95(120Vac)	≤50°C
LF-GLD035YI	35W	36-48	350-750	87%(120Vac)	0.95(120Vac)	≤50°C
LF-GLD045YI	45W	25-38	600-1100	85%(120Vac)	0.95(120Vac)	≤50°C
LF-GLD045YI	45W	36-48	500-1000	85%(120Vac)	0.95(120Vac)	≤50°C
LF-GLD055YI	55W	25-38	700-1300	87%(120Vac)	0.95(120Vac)	≤50°C
LF-GLD055YI	55W	36-48	650-1050	87%(120Vac)	0.95(120Vac)	≤50°C

Specification

Item	Parameter
• Operating Voltage	100-277Vac
• THD	≤20%
• Ta	-30°C ~ +50°C
• Protection Characteristics	Open circuit, short circuit
• Withstanding Voltage	I/P-O/P: 3.75KVac <5mA 60S

Dimensions



LF-GLD035/045/055YI

220-240Vac Linear Metal Casing Non-isolated Series

LF-FMRxxxYS*11-60W

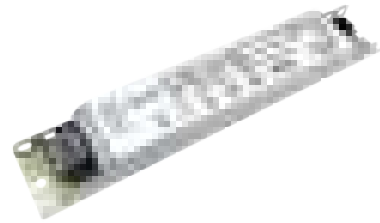

Feature

- High efficiency up to 92%
- Flicker free
- Output current adjustable via the DIP switch (optional)
- Suitable for Class I light fixtures



Parameter

Model	Output Power (Max)	Output Voltage (V)	Output Current (mA)	Efficiency (full load)	PF	Warranty Tc
LF-FMR020YS	20W	25-57	200-350	86%(230Vac)	0.93(230Vac)	≤75°C
LF-FMR040YS	40W	58-114	200-350	90%(230Vac)	0.93(230Vac)	≤72°C
LF-FMR060YS	60W	115-172	200-350	92%(230Vac)	0.93(230Vac)	≤78°C

Specification

Item	Parameter
• Operating Voltage	220-240Vac; 310-340Vdc
• Operating Voltage Limit	198-264Vac; 280-374Vdc
• THD	≤20%
• Ta	-20°C ~ +50°C
• Tc	90°C
• Protection Characteristics	Open circuit, short circuit
• Withstanding Voltage	I/P-O/P: 3.75KVac <5mA 60S

Dimensions

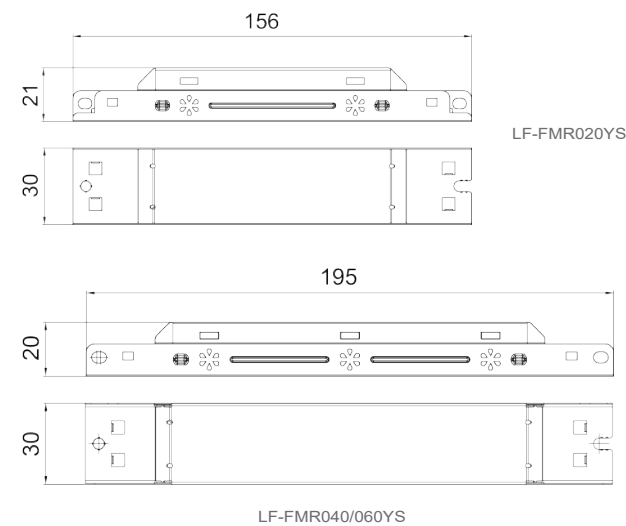

220-240Vac Linear Plastic Casing Non-isolated GEN II Series

LF-FMRxxxYS II *11-60W



Feature

- Output current & CCT adjustable via the DIP switch
- Support external and built-in assembly
- Flicker free
- Suitable for Class I & II light fixtures



Parameter

Model	Output Power (Max)	Output Voltage (V)	Output Current (mA)	Efficiency (full load)	PF	Warranty Tc
LF-FMR020YS II	20W	25-57	200-350	86%(230Vac)	0.93(230Vac)	≤84.5°C
LF-FMR040YS II	40W	58-114	200-350	90%(230Vac)	0.93(230Vac)	≤87°C
LF-FMR060YS II	60W	115-172	200-350	92%(230Vac)	0.93(230Vac)	≤84.5°C

Specification

Item	Parameter
• Operating Voltage	220-240Vac; 310-340Vdc
• Operating Voltage Limit	198-264Vac; 280-374Vdc
• THD	≤20%
• Ta	-30°C ~ +50°C
• Tc	90°C
• IP Rating	IP20
• Protection Characteristics	Open circuit, short circuit
• Withstanding Voltage	I/P-O/P: 3.75KVac <5mA 60S

Dimensions

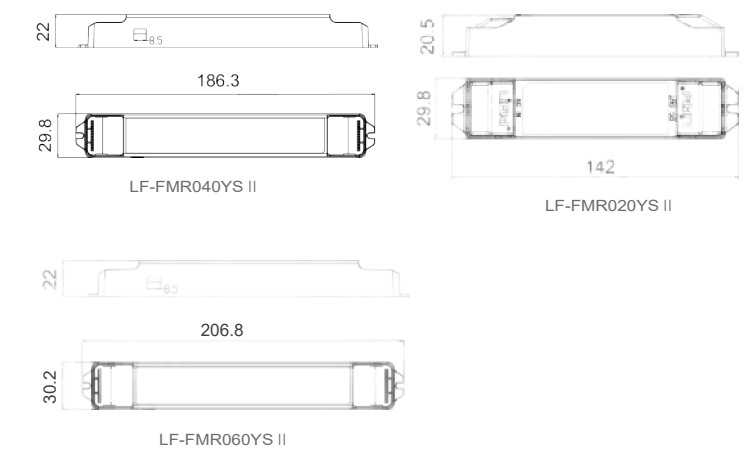

220-240Vac Linear Isolated Conventional Series

LF-GMRxxxYE II *8-60W

91%

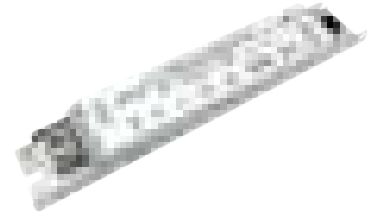

Feature

- Higher efficiency up to 91%
- Optional: external assembly (Class II) or built-in assembly (Class I)
- ENEC, CB & CE certificates for both the built-in and the external assembly; RCM & CCC certificates for the built-in assembly
- Suitable for Class I light fixtures



Parameter

Model	Output Power (Max)	Output Voltage (V)	Output Current (mA)	Efficiency (full load)	PF	Warranty Tc
LF-GMR020YE II	20W	27-40	200-500	89%(230Vac)	0.95(230Vac)	≤70°C
LF-GMR030YE II	30W	27-40	550-750	90%(230Vac)	0.95(230Vac)	≤80°C
LF-GMR040YE II	40W	27-40	800-1000	91%(230Vac)	0.95(230Vac)	≤84°C
LF-GMR050YE II	50W	27-40	1050-1250	91%(230Vac)	0.95(230Vac)	≤90°C
LF-GMR060YE II	60W	27-40	1300-1500	91%(230Vac)	0.96(230Vac)	≤90°C

Specification

Item	Parameter
• Operating Voltage	220-240Vac
• Operating Voltage Limit	198-264Vac
• THD	≤20%
• Ta	-30°C~+50°C
• Tc	90°C
• Protection Characteristics	Open circuit, short circuit
• Withstanding Voltage	I/P-O/P: 3.75KVac <5mA 60S



LF-GMR050/060YE II

Dimensions

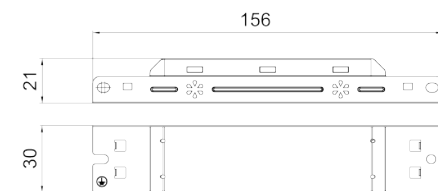

LF-GMR020YE II



LF-GMR030/040YE II

220-240Vac Linear Isolated Series

LF-GMRxxxYS II*8-84W

FLICKER FREE

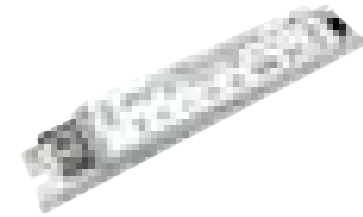

Feature

- Flicker free, percent flicker less than 0.5%
- Higher efficiency up to 89%
- Suitable for Class I light fixtures



Parameter

Model	Output Power (Max)	Output Voltage (V)	Output Current (mA)	Efficiency (full load)	PF	Warranty Tc
LF-GMR020YS II	20W	33-42	200-550	86%(230Vac)	0.94(230Vac)	≤70°C
LF-GMR030YS II	30W	33-42	600-780	88%(230Vac)	0.94(230Vac)	≤67°C
LF-GMR040YS II	40W	33-42	800-1050	89%(230Vac)	0.95(230Vac)	≤65°C
LF-GMR060YS II	60W	33-42	1100-1550	89%(230Vac)	0.95(230Vac)	≤75°C
LF-GMR080YS II	80W	33-42	1600-2000	89%(230Vac)	0.95(230Vac)	≤65°C

Specification

Item	Parameter
• Operating Voltage	220-240Vac
• Operating Voltage Limit	198-264Vac
• THD	≤20%
• Ta	-30°C~+50°C
• Tc	80°C
• Protection Characteristics	Open circuit, short circuit
• Withstanding Voltage	I/P-O/P: 3.75KVac <5mA 60S I/P-FG: 1.6KVac <5mA 60S O/P-FG: 0.5KVac <5mA 60S

Dimensions

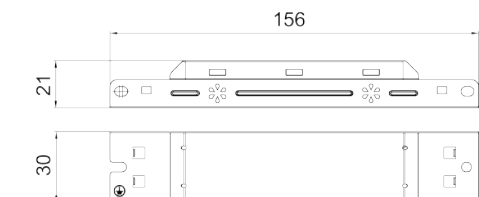

LF-GMR020YS II

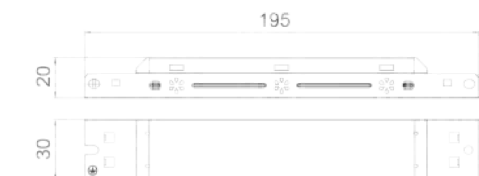

LF-GMR030/040YS II

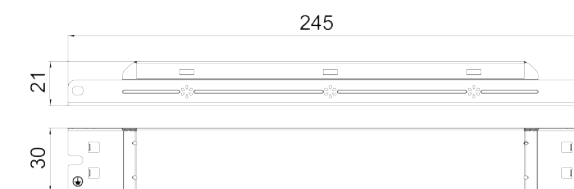

LF-GMR060YS II



LF-GMR080YS II

220-240Vac Linear 3-in-1 Dimming Series

LF-GLDxxxYE* 11-80W

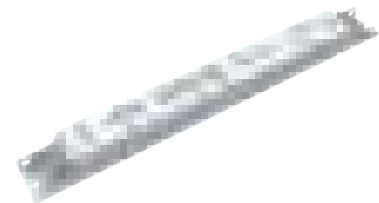

Feature

- 3-in-1 dimming function: 0-10V/PWM/Rx
- Efficiency up to 89%
- Two sets of input L/N terminals
- Flicker free
- Suitable for Class I light fixtures



Parameter

Model	Output Power (Max)	Output Voltage (V)	Output Current (mA)	Efficiency (full load)	PF	Warranty Tc
LF-GLD025YE	25W	25-42	250-550	87%(230Vac)	0.90(230Vac)	≤73°C
LF-GLD035YE	35W	25-42	600-800	87%(230Vac)	0.90(230Vac)	≤72°C
LF-GLD045YE	45W	25-42	850-1050	88%(230Vac)	0.90(230Vac)	≤88°C
LF-GLD055YE	55W	25-42	1100-1300	88%(230Vac)	0.90(230Vac)	<88°C
LF-GLD065YE	65W	25-42	1300-1550	89%(230Vac)	0.90(230Vac)	≤84°C
LF-GLD080YE	80W	25-42	1900-2000	89%(230Vac)	0.90(230Vac)	≤84°C

Specification

Item	Parameter
• Operating Voltage	220-240Vac
• Operating Voltage Limit	198-264Vac
• THD	≤20%
• Ta	-30°C~+50°C
• Tc	90°C
• IP Rating	IP20
• Protection Characteristics	Open circuit, short circuit
• Withstanding Voltage	I/P-O/P: 3.75kV/ 5mA/ 60S I/P-FG: 1.6kVac <5mA 60S O/P-FG: 0.5kVac <5mA 60S

Dimensions

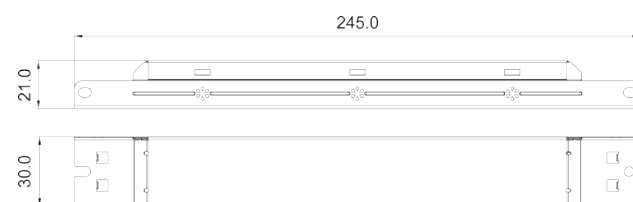

LF-GLD025/035/045YE

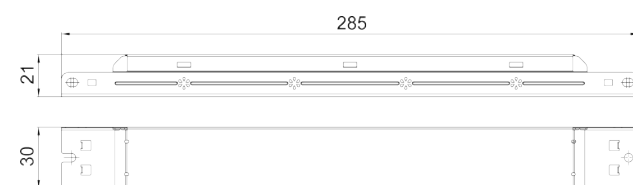

LF-GLD055/065YE

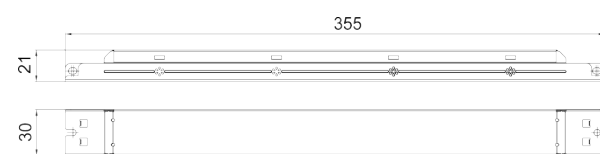

LF-GLD080YE

100-277Vac Linear 3-in-1 Dimming Series

LF-GLDxxxYS*11-65W

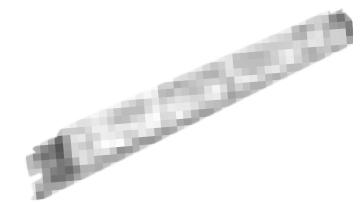

Feature

- 3-in-1 dimming: 0-10V/PWM/Rx
- The output circuit is isolated from the dimming circuit
- Flicker free
- Suitable for Class I light fixtures



Parameter

Model	Output Power (Max)	Output Voltage (V)	Output Current (mA)	Efficiency (full load)	PF	Warranty Tc
LF-GLD025YS	25W	25-42	250-550	85%(277Vac)	0.90(277Vac)	≤70°C
LF-GLD035YS	35W	25-42	600-800	86%(277Vac)	0.90(277Vac)	≤73°C
LF-GLD045YS	45W	25-42	800-1100	86%(277Vac)	0.90(277Vac)	≤75°C
LF-GLD055YS	55W	25-42	1100-1300	87%(277Vac)	0.90(277Vac)	≤67°C
LF-GLD065YS	65W	25-42	1300-1550	88%(277Vac)	0.90(277Vac)	≤72°C

Specification

Item	Parameter
• Operating Voltage	100-277Vac
• Operating Voltage Limit	90-305Vac
• THD	≤20%
• Ta	-30°C~+50°C
• Tc	90°C
• Protection Characteristics	Open circuit, short circuit
• Withstanding Voltage	I/P-O/P: 3.75kV <5mA 60S I/P-FG: 1.6kVac <5mA 60S O/P-FG: 0.5kVac <5mA 60S

Dimensions



LF-GLD025/035/045YS



LF-GLD055/065YS

Naming Rule

for Lifud C.C. & C.V. LED Driver

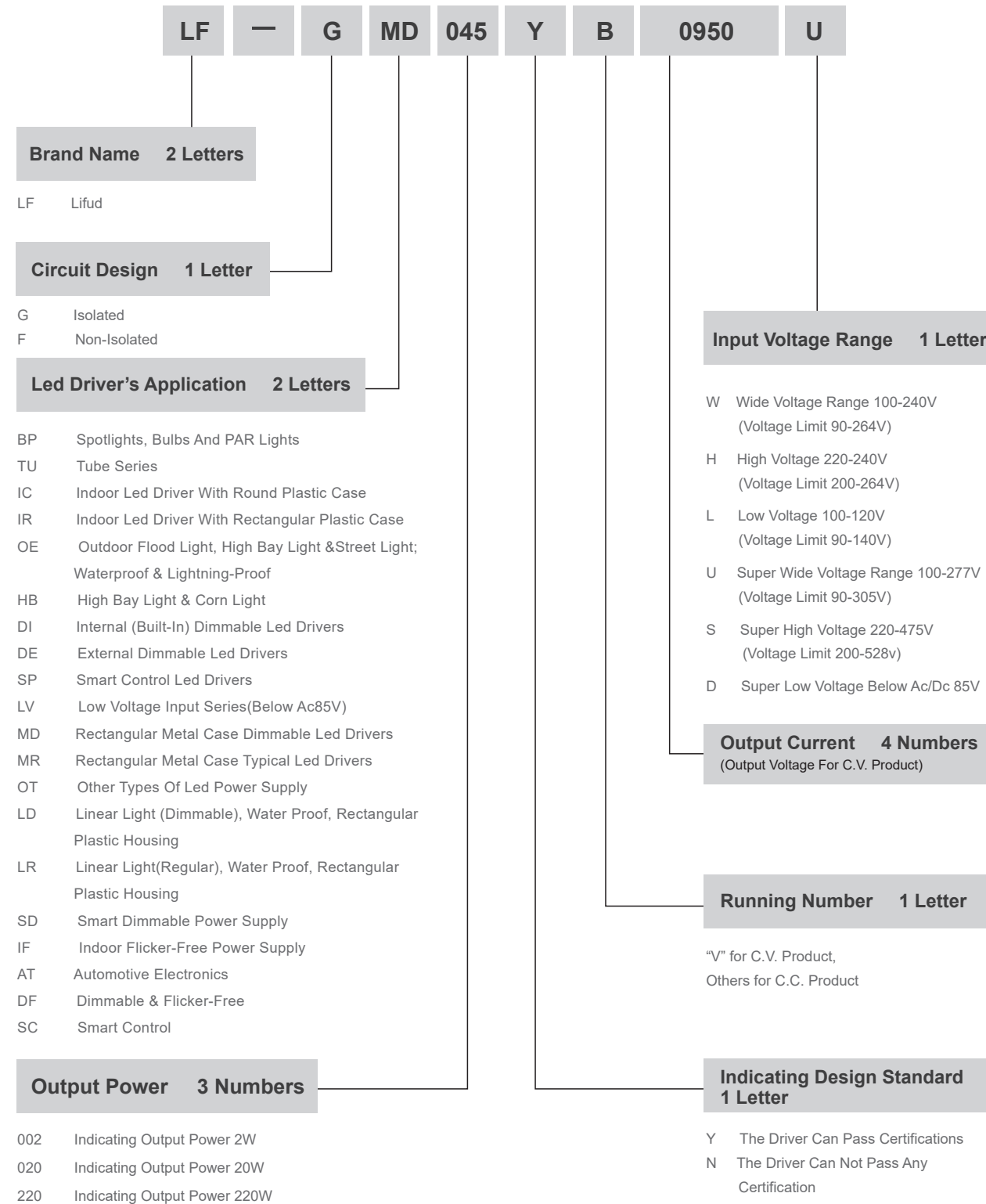

Leading Supplier of
LED Driver & Intelligent
System Solution